

Sustainable Drainage Systems Design Guide



Essex County Council December 2014



Essex County Council

Terms of Reference and Composition of SuDS Guide Working Group and Steering Group

The Working Group, formed to look at producing a SuDS Design and Adoption Guide, consisted of representatives from various departments within Essex County Council (ECC), who reflect a range of related disciplines. The Steering Group consisted of representatives from Essex County Council as well as external organisations. The objective of the Groups was to:

“Develop a Design Guide demonstrating how new developments can accommodate SuDS, the standards expected of any new SuDS scheme to be suitable for approval and adoption, provide an overview of the geology and biodiversity of the county and advice on how SuDS will be maintained and how they should be ensured to be maintainable.”

This has been achieved by:

- Reviewing background information and current advice
- Collecting suitable case studies within Essex
- Considering updates from Defra and the National Standards Consultation
- Taking on board comments from restricted and public consultations.

The Working Group comprises ECC Officers:

Planning & Environment

Keith Lawson
Phil Callow
Lucy Shepherd
Kathryn Goodyear
Tim Simpson

Development Management, Essex Highways

Vicky Presland
Peter Wright
Peter Morris
Philip Hughes

Place Services

Crispin Downs
Peter Dawson

The Steering Group comprises those above plus additional members representing:

Essex Highways: David Ardley
Environment Agency: Graham Robertson
Mersea Homes: Brad Davies
Bellway Homes : Clive Bell/Ben Ambrose
Barratt Homes: Rodney Osborne
Persimmon Homes: Terry Brunning
Countryside Properties: Andrew Fisher
Essex Legal Services: Alan Timms
Tendring District Council: John Russel
Basildon District Council: Matthew Winslow
Epping Forest District Council: Quasim Durrani

CONTENTS

Terms of Reference and Composition of SuDS Guide Working Group and Steering Group	(i)	4.3	Schools	64
		4.4	Roads	67
1.0 Introduction	1	5.0 Appendices		68
1.1 Surface Water and Urbanisation	2	Appendix 1: Rainwater Harvesting and Greywater Recycling		70
1.2 The Flood and Water Management Act	2	6.0 Glossary of Terms and Acronyms		80
1.3 Sustainable Development	3	7.0 References		85
1.4 The Purpose of this Guide	4	8.0 Figure Table		86
1.5 The Structure of this Guide	4			
1.6 The SuDS Management Train	5			
2.0 SuDS and the Essex Environment	6			
2.1 Topography	7			
2.2 Rainfall	7			
2.3 Geology	8			
2.4 Historic Environment	11			
2.5 Landscape and Townscape Character	12			
2.6 Nature Conservation	12			
3.0 Design Criteria	14			
3.1 Local Principles	16			
3.2 Local Standards	27			
4.0 Designing SuDS	35			
4.1 The Planning and Design Process	37			
4.2 Design Examples	40			
4.2.1 Mews Courtyard	41			
4.2.2 Informal Street	47			
4.2.3 Mixed Use Street	53			
4.2.4 High Density Neighbourhood	59			

>>Rieselfeld, Freiburg, Germany



1.0 INTRODUCTION

1.0 INTRODUCTION

1.1 Surface water and urbanisation

Sustainable Drainage Systems (SuDS) are nothing new. They have been nature's way of dealing with rainfall, since time began. At its simplest, rain falling on the land may evaporate or be absorbed into the soil, nourishing our natural habitat, or else flows overland into ponds, ditches, watercourses and rivers, helping to sustain life by replenishing our precious water resource.

It is only recently that the balance of this natural water cycle has been disrupted. Modern urban development with its houses, roads and other impermeable surfaces has increasingly altered the way that rainwater finds its way into our soils, rivers and streams. Surface water has for many years been allowed to be collected and piped directly into our ditches and rivers. Conveying water away as quickly as possible from a development may adequately protect the immediate development from flooding but increases the risk of flooding occurring downstream. This unsustainable approach to surface water drainage, together with the potential effects of a changing climate, has contributed to some very serious consequences on life, property and the environment as evidenced by the disastrous

flooding experienced throughout the UK during the summer of 2007.

1.2 The situation

As the Lead Local Flood Authority (LLFA) Essex County Council is responsible for overseeing flood risk from surface water, groundwater and ordinary watercourses. The LLFA is therefore expected to provide support to Local Planning Authorities and the development industry on sustainable drainage proposals.

This document forms the local standards for Essex and, together with the National Standards, strongly promotes the use of SuDS which help to reduce surface water runoff and mitigate flood risk.

A return to more natural, sustainable methods of dealing with surface water from development will also have additional benefits for:

- Water quality – SuDS can help prevent and treat pollution in surface water runoff, protecting and enhancing the environment and contributing towards Water Framework Directive objectives.
- Amenity – SuDS can have visual and community benefits for the community



Bio-retention planters, Portland, Oregon, USA



SuDS wetlands, Wellesley College, USA

- Ecology – SuDS can provide the opportunity to create and improve habitats for wildlife, enhancing biodiversity

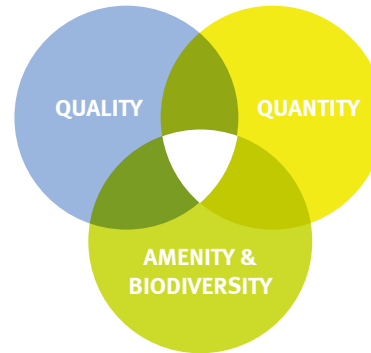

Figure 1.2.1 SuDS objectives (CIRIA, 2007)

See also:
Water Framework Directive on the
Environment Agency's website: [http://
www.wfduk.org/](http://www.wfduk.org/)

1.3 Sustainable development

Essex County Council is committed to making our county a place which provides the best possible quality of life for all who live and work here. Making it more sustainable is an important part of supporting this vision and it is therefore implicit that new development

should incorporate sustainability measures that help achieve this goal.

Appropriately designed, constructed and maintained SuDS support the ideal of sustainable development. SuDS are more sustainable than conventional surface water drainage methods as they can mitigate many of the adverse effects that stormwater run-off has on the environment. This can be achieved by:

- Reducing run-off rates, thereby lessening the risk of flooding downstream
- Minimising additional run-off emanating from urban development, which could exacerbate the risk of flooding and impair water quality
- Encouraging natural groundwater recharge (as appropriate) and so reduce the impact on aquifers and rivers
- Reducing pollution risks associated with development
- Contributing to and enhancing the amenity and landscape of an area and so promoting community involvement and enjoyment
- Providing habitats for wildlife and opportunities for biodiversity enrichment.

1.4 The purpose of this guide

This guide is primarily intended for use by developers, designers and consultants who are seeking guidance on the County Council's requirements for the design of sustainable surface water drainage in Essex. It provides information on the planning, design and delivery of attractive and high quality SuDS schemes which should offer multiple benefits to the environment and community alike. It should also show that meeting these requirements need not be an onerous task and can help add to development.

The County Council, as LLFA, will refer to this Guide when it is consulted on planning applications relating to sustainable drainage. Pre-application advice may be sought from the County Council as early on in the process as possible. This guide provides a steer as to what is expected and should complement national requirements whilst prioritising local needs.

SuDS philosophy and concepts are based upon and derived from The SuDS Manual (CIRIA 2007). It is not the intention that this guide reproduces or replaces The SuDS Manual; moreover it should be seen as complementing the source document and so users of this guide should familiarise themselves with 'The SuDS Manual' and incorporate advice from both

documents into their SuDS proposals.

1.5 The structure of this guide

This guide aims to bring to life the expectations that Essex County Council has from SuDS through case studies and worked examples. Chapter 2 provides an overview of the design considerations specific to the county such as topography. Chapter 3 provides a quick overview of the standards that are expected

not just in terms of flood prevention but also amenity, ecology and water quality. It also provides an introduction to the main forms of SuDS features and when they are most suitable. Chapter 4 illustrates this information with a series of worked examples of major types of development. These show how SuDS could be fitted into real life situations. There are also case studies, showing how it has been achieved before.



Multi-functional open space, Rieselfeld, Freiburg, Germany

1.6 The SuDS management train

Sustainable drainage systems are now the preferred method for managing surface water run-off from a development area. In order to imitate the natural drainage of a site a series of drainage techniques (the “management train”) should be employed to reduce flow rates and volumes, minimise pollution and so reduce the impact of the quantity and quality of water emanating from a development. These techniques need to be applied progressively from prevention, source control, site control through to regional control.

See also:

More information on the elements of the SuDS management train: Section 1.3 of The SuDS Manual (CIRIA 2007).

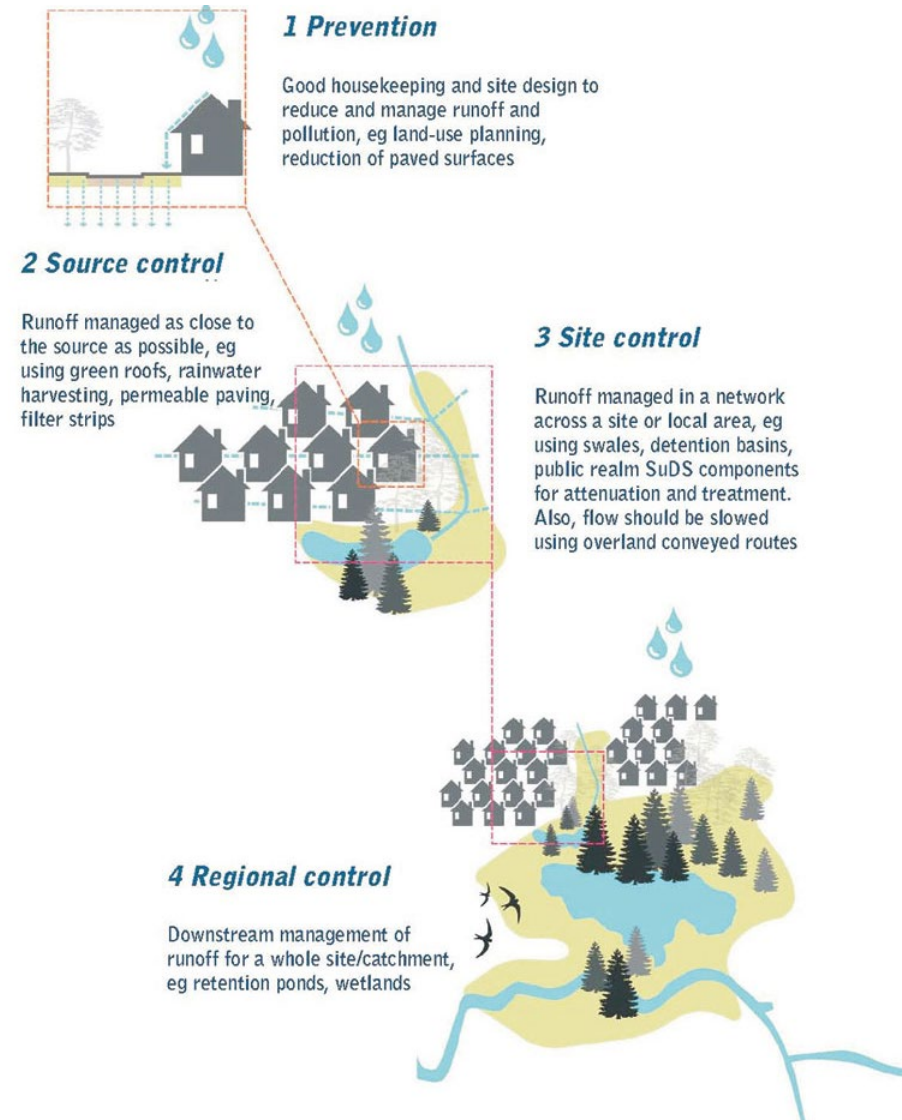

Figure 1.6.1 The SuDS management train (CIRIA, 2010)



»»18th-19th century duck decoy pond, Old Hall Marshes, Maldon, Essex

2.0 SuDS AND THE ESSEX ENVIRONMENT

2.0 SUDS AND THE ESSEX ENVIRONMENT

This section provides an overview of design considerations specific to the county including topography, drainage patterns, rainfall, geology and soils, landscape and townscape character and nature conservation.

2.1 Topography

Essex is a county of low hills and undulating valleys, with extensive areas of low flat land near to the coast. The altitude rises very gently from the coast towards the north-west, reaching about 30m around Chelmsford and just over 130m to the west of Saffron Walden, as can be seen in Figure 2.3.2. This gentle rise is interrupted by a series of low hills and ridges, the highest of which is Danbury Hill at 116m. The county has a large number of small rivers, largely as a consequence of the proportion of clay soils. These rivers are an important component of the county's topography, character and identity. The river corridors are frequently of value for landscape, nature conservation and heritage, as well as providing public access opportunities and the focus for recreation.

The low infiltration rate of many of Essex's soils lead historically to water features in the landscape – many ponds, open ditches, small

streams, wetland and marsh. Many of these have been drained or piped over the last few centuries, with few of these features surviving as part of a managed drainage system.

2.2 Rainfall

Across most of East Anglia there are, on average, about 30 rain days (rainfall greater than 1 mm) in winter (December to February) and less than 25 days in summer (June to August).

Climate changes already seen in the UK are consistent with the UKCP02 scenarios. These suggested that winters would become wetter over the whole of the UK, by as much as 20% by the 2050's. A shift in the seasonal pattern of rainfall is also expected, with summers and autumns becoming much drier than at present, but the number of rain days and the average intensity of rainfall are overall expected to increase. The latest UK Climate Projections (UKCP09) show that in the south east of England there is a 90% chance that winter mean precipitation will increase by 55%, and summer mean precipitation will increase by 7%, by the 2080's.

See also:

More on climate change projections:
www.ukclimateprojections.defra.gov.uk



Coastal marshes, Colne Estuary, Essex

2.3 Geology

The bedrock of Essex (see figure 2.3.1) forms part of the eastern sector of the London Basin chalk syncline which outcrops in the north west, near Saffron Walden. London Clay is the thickest Tertiary deposit with an extensive outcrop across the centre of the county running from east to west which is capped locally by loamy Claygate and sandy Bagshot Beds.

The bedrock geology of Essex is covered by a veneer of superficial or 'drift' deposits, (see figure 2.3.3) such as sand and gravel, that were laid down during the Ice Age. Succeeding deposits have overlaid the sands and gravels but exposures are common on the valley sides and on the Tendring plateau. Soil forming processes in a succeeding interglacial left the

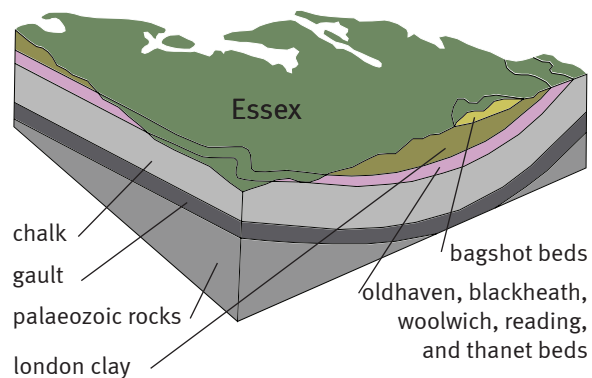

Figure 2.3.1: Simplified bedrock section



Exposed glacial gravels, East Mersea, Essex

upper part of the sands and gravels reddened and clay enriched.

A vast sheet of Boulder Clay, which contains clay, flints and chalk, was deposited over central and northern Essex in a successive glacial period. The ground has been disturbed by solifluction and windblown silts accumulated to form brickearths and loam deposits. Continuous periods of sea level rise brought extensive deposits of sand and gravel

which have formed eight terraces known as the Kesgrave Formations and further variations in sea level formed the East Essex Gravels on the Dengie peninsula, Rochford and Shoeburyness.

Over half of the agricultural land in Essex is of 'best and most versatile' quality (Grade 1, 2 or 3a), however on the coastal marshes much of the land has been reclaimed and the soils are heavy gleys that undergo periodic waterlogging from fluctuations in the ground

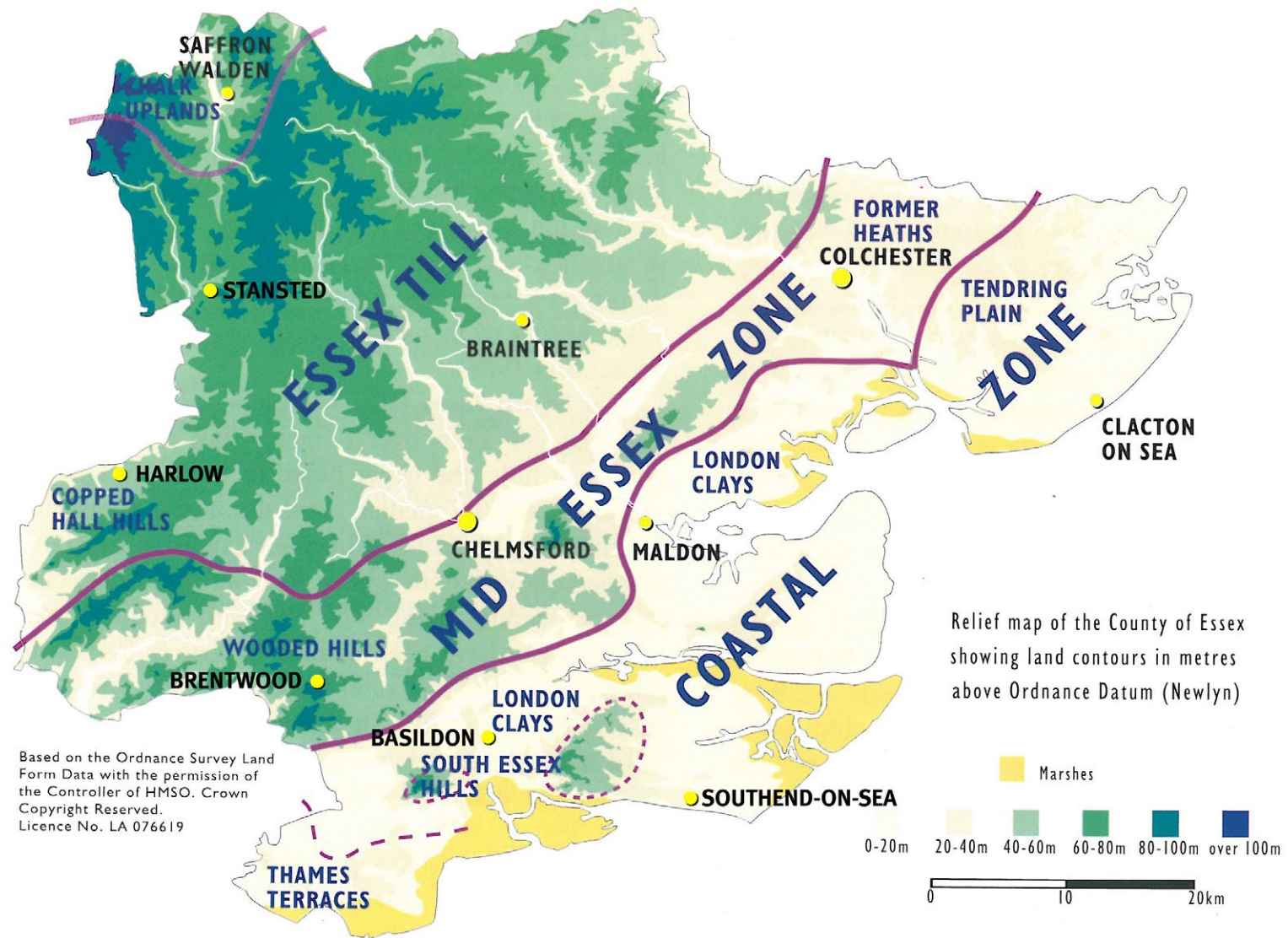

Figure 2.3.2 Topography of Essex

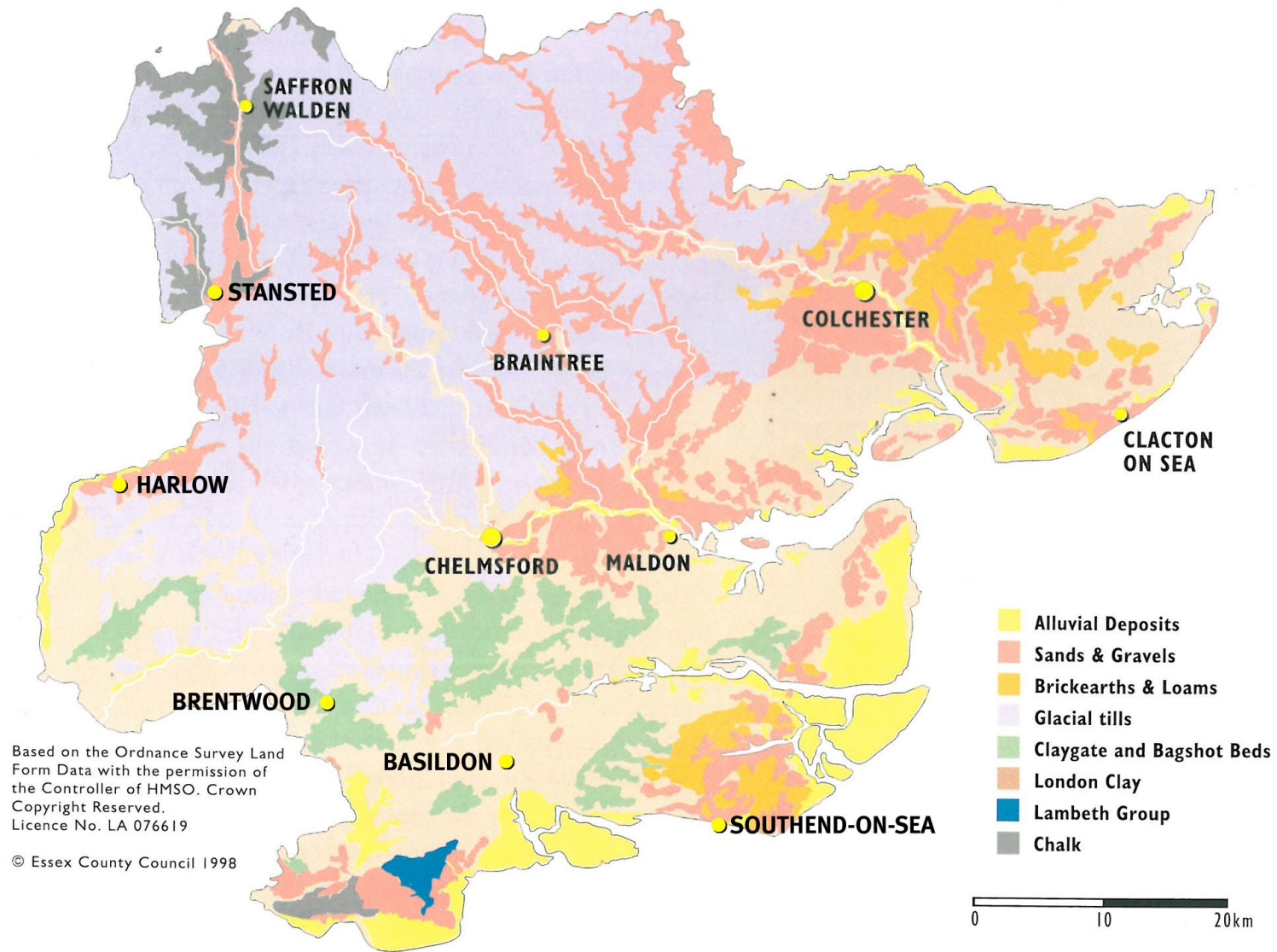

Figure 2.3.3 Surface geology of Essex

water table. Inland soils are often naturally free draining brown soils, especially where brickearth is present. Soils on the London Clay are seasonally waterlogged slowly permeable heavy clay soils. On the hills that rise above the London Clay the fine sands of the Bagshot Beds are capped by the pebbly clay drifts. The soils on the boulder clay plateau to the north range from wet acidic clay soils to dry neutral/alkaline soils which require under-draining for farming. The valley soils are complex but tend to be better drained and the soils that form in the north west of the county are free draining.

2.4 Historic Environment

Essex has a rich and varied historic environment that encompasses the physical legacy of thousands of years of human activity in the form of historic buildings and structures, archaeological sites and monuments, and historic landscapes. The historic environment makes a particular contribution to the character and value of the county's landscapes and provides a wide range of benefits, including contributing to local distinctiveness, and people's sense of place and community. Essex County Council maintains the most complete record of the county's historic environment, comprised of around 38,000 known heritage assets, including 838 Scheduled Monuments, to help ensure that decisions which affect the

historic environment are made from a sound knowledge base.

The impact of new developments, including SuDS, on heritage assets which are not subject to a statutory designation are considered and mitigated through the planning process. In this context, information and advice on the historic environment significance of areas affected by new SuDS, and of the mitigation that may be needed to reduce their impacts on the

historic environment should be sought from the historic environment specialists in Essex County Council's Place Services team, and where relevant, English Heritage.

See also:
Essex County Council's Historic
Environmental Record: www.essex.gov.uk/activities/heritage
Information and advice from English
Heritage:
www.english-heritage.org.uk



Agricultural land, Little Waltham, Essex

2.5 Landscape and Townscape Character

Planning policy requires developers to consider context carefully and to use documents for characterisation to inform their proposed layouts and detail design. A more detailed assessment of any proposed development site is required to assess areas for conservation or protection and habitats which could be objectives for the development.

Essex broadly comprises seven landscape character types. These are Chalk Upland, Glacial Till Plateau, River Valley, Wooded Hill and Ridge, London Clay, Coastal and Urban. There is a further subdivision into 35 'character areas' with definition of what is distinctive about each.

Most of the Districts have their own landscape character assessments and with areas further defined and looked at in even greater detail. There are also a number of townscape assessments which describe and analyse the pattern and history of development, and the style and quality of buildings.

All these documents are valuable in understanding how to create a landscape with its proposed SuDS for a development so it fits into the landscape and townscape of the area.



River Chelmer, Chelmer Conservation Area, Essex

2.6 Nature Conservation

Although largely arable in character, Essex still supports a considerable variety of semi-natural habitats many of which are scarce or threatened nationally.

The Essex coast and its estuaries are recognised as one of the most important areas for wildlife in the UK, with a significant proportion protected by national and international designation primarily due to the large numbers of wildfowl

and wading birds that visit the mudflats, saltmarshes and grazing marshes in winter.

Away from the coast, the most significant internationally and nationally important habitats are the wood-pastures of west Essex such as Epping Forest, Hatfield and Thorndon; and the wetlands of Abberton Reservoir, the Lee Valley and Hanningfield Reservoir.

Other valuable and characteristic Essex habitats include the oxlip woodlands on the



Ramsey Creek, Tendring, Essex

chalky-boulder clays of the northwest, the ancient hornbeam and bluebell woodlands of the southern ridge-lines, and the unique invertebrate assemblages of the proto-Thames/Medway terrace gravels and sands.

See also:

More information about statutory designated international and national areas:

www.natureonthemap.naturalengland.org.uk

Details about the location and character of Local Wildlife Sites:

www.localwildlifesites.org.uk



>>SuDS Pond, Western Harbour, Malmo, Sweden

3.0 DESIGN CRITERIA

3.0 DESIGN CRITERIA

Design criteria provide a framework for designing a system to effectively drain the area to protect public health and safety and the environment, creating natural habitat where possible.

The National Standards for SuDS design set out the required design principles and standards, but also provide for Local Standards to be set to ensure SuDS design responds to local conditions and priorities. This guidance builds on the National Standards, by outlining local expectations within Essex. Local Planning Authorities may make reference to the local standards as the requirements for SuDS design within their Local Plans. This provides a consistent approach to dealing with surface water drainage across the County.

In the case of site redevelopments some of the design criteria may not be appropriate and should be discussed at the pre-application stage.

See also:

The National Standards and accompanying guidance, available from the Defra website:
www.defra.gov.uk

SuDS retrofitting is described in more detail in:
Retrofitting to manage surface water (C713) (CIRIA, 2012)

Further objectives and principles set out in:
The SuDS Manual (CIRIA, 2007)



Wetlands store/treat run off at residential development, EOS Bostadsrättsförening, Sweden

In those areas where a Surface Water Management Plan is in place, drainage designs should also take into account any recommendations made in that Plan

This section sets out our Local Principles (Section 3.1) and Local Standards (Section 3.2) expected in Essex:

Local Principles:

1. Plan for SuDS
2. Integrate with public spaces
3. Manage rainfall at the source
4. Manage rainfall at the surface
5. Mimic natural drainage
6. Design for water scarcity
7. Enhance biodiversity
8. Link to wider landscape
9. Design to be maintainable
10. Use a precautionary approach
11. Have regard to the historic environment
12. Show attention to detail

Local Standards:

1. Hydraulics
2. Water quality
3. Green roof design
4. Soakaway design
5. Filter strip design
6. Filter trenches and drain design
7. Swale design

8. Bioretention design
9. Pervious pavement design
10. Geocellular structures design
11. Infiltration basin design
12. Detention basin design
13. Pond design
14. Wetland design
15. Rainwater harvesting design
16. Greywater recycling design

3.1 Local Principles

Our Local Principles are intended to supplement the National Standards and aid in the evaluation of SuDS proposals.

LOCAL PRINCIPLE 1: PLAN FOR SUDS

SuDS should be considered as early in the planning process as is feasible.

As SuDS can impact far more visibly and dramatically on a development than conventional drainage, an integrated and multi-disciplinary approach to site planning and design is the key to a successful SuDS system.

Investing in good design and identifying the requirements, issues and opportunities for SuDS at the early stages of a project is



SuDS infiltration basins have been integrated with highways at Ravenswood in Ipswich. The scheme is estimated to have saved over £600,000 in the long term (Ipswich Borough Council, 2011)

very likely to be repaid in the long-term. The advantages include:

- Early consultation with risk management authorities can prove extremely useful and save wasted time later on
- SuDS requirements will inform the layout of buildings, roads and open spaces, which can reduce land-take and minimise potential conflicts later on
- Where soils vary across the site, SuDS features can be located on permeable soils to reduce the amount of storage required
- Existing landscape features can be integrated in designs to reduce costs
- Water features can be designed and located to enhance the desirability of a scheme.

The opportunity for regional control may be identified if there are existing features on or nearby to the development site that could provide downstream management of runoff for numerous sites or a whole catchment, or if an area has been identified for flood storage in an Action Plan as part of a Surface Water Management Plan.

See also:

More detail in:

Section 4.1 of this Guide

Planning for SuDS (CIRIA, 2010)

Progress on Surface Water Management Plans can be seen at: www.essex.gov.uk/flooding

LOCAL PRINCIPLE 2: INTEGRATE WITH PUBLIC SPACES

SuDS should be combined with public space to create multi-functional use areas and provide amenity.

Visual Impact and Amenity Benefit

SuDS have the potential to be integrated into public open spaces which can be both attractive to potential house buyers through the provision of areas for example for dog-walking and provide vital surface water drainage. SuDS that



Basins and swales carved from the slopes at Manor Park in Sheffield store and treat run-off from residential areas (above) and are used for events space when dry (below) (Sheffield City Council, 2011)



are designed with aesthetics in mind will ensure public acceptability and can be beneficial to the public realm. Key considerations to provide amenity benefit are the use of vegetation and landscaping techniques, linking open water areas to recreation sites, setting an appropriate maintenance programme to ensure areas are visually attractive throughout the year and informing and educating the public of the role of SuDS.



Shallow slopes, low water depth and stable edges minimise the need for fences and illustrate a designed approach to health and safety

The use of smaller areas of POS can also significantly contribute to the overall capacity of the site if designed correctly. Features such as extended curbs can combine traffic calming with the opportunity to introduce bio-retention

areas. An overall site design that focuses on multiple smaller features rather than one or two features at the end of a system can provide increased source control, greater resilience if a single feature becomes blocked and better use of space on site that have a limited capacity for above ground SuDS.

The Life Project (BACA Architects & BRE, 2009) found that sustainable drainage could be integrated with open space provision and used for recreation. In fact, when other demands on the available land are taken into account, it becomes essential to consider SuDS as part of a broader green infrastructure rather than stand-alone features.



Moving surface water, lush vegetation and undulating landforms can enrich open spaces

SuDS should be one piece of a larger working landscape which acts as an amenity space, stores and treats run off, alleviates flooding, enhances biodiversity and provides renewable energy sources.

Features such as ponds, detention basins and swales bring moving water, undulating landforms and nature to people's doorsteps. SuDS can be designed to accommodate large volumes of water during heavier events but remain dry the rest of the time to allow for recreation and events. Boardwalks, stepping stones and bridges can be provided to allow access across wetter areas. Shallow slopes, low water depths, strategically placed vegetation and stable ground around water margins help to create a safe environment for site users. Treatment and monitoring of pollutants upstream of accessible SuDS features must be carefully designed.

The aim should be to create networks of high quality open space which adapt for attenuation of surface water, sports and play and enhancement of biodiversity (BRE, 2010).

Health and Safety

The main risks associated with SuDS are:

- Drowning
- Slips, trips and falls
- Waterborne disease
- Wildfowl strikes near airports.

In the majority of situations these potential risks are removed through good site design and layout. The risk of drowning and falls can be managed by installing gentle slopes, shallow ponds, safety benches and access points. However, there may be exceptions where it is appropriate to install avoidance measures, minimal fencing to protect small children for example.

The use of SuDS in School environments requires particular consideration with regard



This raingarden controls surface water at source and provides habitat for wildlife.

to health and safety. We will engage with Schools at an early stage to determine what is considered acceptable.

Systems should also avoid small stagnant pools which could lead to waterborne disease.

Ensuring that SuDS remain safe and accessible for the life-time of the developments they serve is principal to their design. Along with other aspects, health and safety must first be considered at the pre-application stage. We will only approve and adopt SuDS where the risks have been formally assessed taking into account future amenity and maintenance requirements.

The Construction, Design and Management Regulations (CDM) (HSE, 2007) must be applied to the planning, design and construction, and long-term maintenance of SuDS. CDM regulations will apply to the majority of SuDS projects. The regulations ensure all foreseeable risks are assessed. Any unacceptable risk should then be removed through design as a preference, before avoidance and mitigation measures need to be considered. A Health and Safety file must be produced and passed over to the SuDS Team on completion of the adoption process.

Community Engagement

We encourage developers to produce a communications plan raising public awareness. This should address concerns around health and safety and encourage a sensible and responsible approach to living with SuDS.

Danger signs should not be necessary; however information boards which provide details of the type of SuDS features on site can be installed. This will further promote an understanding of how the system functions and the benefits of SuDS.

SuDS that are well designed in line with The SuDS Manual (CIRIA, 2007) should not pose a significant health and safety risk. We will therefore expect SuDS features to be compliant with the design specifications in the SuDS Manual.

Early discussion with the SuDS Team should be undertaken if proposals cannot meet with these standards, and evidence as to why this is the case should be provided.

See also:

More information on the Life Project: www.lifeproject.info
More information on community engagement: Chapter 24 of the SuDS Manual (CIRIA, 2007)

LOCAL PRINCIPLE 3: MANAGE RAINFALL AT THE SOURCE

Management and conveyance of surface runoff should be kept on the surface as far as possible.

There are several distinct advantages in using SuDS, which manage water at the surface in the landscape:

- SuDS maintenance can be incorporated as part a typical landscape maintenance specification
- A range of habitats can be created
- Obstructions and blockages are more easily detected
- Creates visually complex and ever-changing landscape
- Potential to reduce construction costs
- Makes the water cycle visible and provides opportunities for contact with nature and

education

- Can be designed as attractive features to enhance urban design
- Water levels can be more easily monitored

Management of surface water on the surface should include the provision and allowance for infiltration. As detailed below, careful risk assessment and a design-led approach to health and safety concerns is often an effective alternative to fencing around open water.



Sutcliffe Park, London: A common sense approach to health and safety near water (Ian Yarham 2010)

LOCAL PRINCIPLE 4: MANAGE RAINFALL AT THE SURFACE

Surface runoff should be captured as close to where it falls as possible.

It is worth emphasising that SuDS planning and design should seek to control surface water as close to the source as possible. Features such as green roofs, rain gardens, soakaways and permeable paving treat and store water where it falls. They reduce the storage volumes, flow rates and treatment stages of features further down the management train.

As well as considering health and safety and flooding issues, designers should bear in mind how vegetated SuDS features in close proximity to development will be perceived. In order to slow and treat run off effectively, the traditional neatly manicured landscape may need to give way to a more informal aesthetic. Colours, materials, height of vegetation and edges are some of the elements which can be manipulated to give the impression that a feature is intended and cared for.

Although it cannot (at present) be included in storage calculations, the role of mature leafy trees (albeit seasonally in deciduous species) in intercepting rainwater before it hits the ground should not be underestimated.

See also:

Details on how to approach health and safety around water: Local Principle 2 of this guide

LOCAL PRINCIPLE 5: MIMIC NATURAL DRAINAGE

SuDS networks will be designed to match natural drainage routes, infiltration rates and discharges as far as possible.

Designs should work with natural gradients so as to avoid the use of energy consuming water pumps wherever possible, minimise use of man-made materials giving a softer and more natural feel to features and promote infiltration.

One of the main underlying principles of SuDS is that they should mimic natural processes and we would therefore favour systems that avoided the use of pipes or storage tanks. Vegetated SuDS should usually be given priority over pure engineering solutions as their operation is easier to observe and maintain. Below-ground features are not sustainable in the long term as they are not easily maintainable and have a limited life in comparison to grassed and more natural systems. We would discourage SuDS systems which were reliant on electricity or any kind of pumped system which require specialised maintenance.

LOCAL PRINCIPLE 6: DESIGN FOR WATER SCARCITY

New development should employ rainwater/ greywater re-use in areas of water scarcity.

Designers and planners should obtain from the local water supply company information about the degree of water scarcity (including climate change implications for water resource security and likely increases in demand) in the area of the development. Where there is pressure on water resources, rainwater harvesting systems should form part of the surface water management strategy for the site. Further information on rainwater harvesting and greywater recycling is provided in Appendix 1.

See also:

Further advice on landscaping and health and safety near airports is provided in Chapter 20 of the SuDS Manual (CIRIA, 2007)

Full details of the CDM requirements and an example of a site-specific risk assessment in: Section 2.5.10 and Section 3.4.2 of The SuDS Manual (CIRIA, 2007)

LOCAL PRINCIPLE 7: ENHANCE BIODIVERSITY

SuDS should be designed to improve biodiversity whenever possible.

Maximising the ecological value of SuDS is consistent with national and local policies which aim to conserve and enhance biodiversity. This is underpinned by a variety of legislation including a biodiversity ‘duty’ for public bodies which is enshrined in the Natural Environment and Rural Communities (NERC) Act 2006.



SuDS at Wellesley College are connected to wetlands outside the site boundary to create valuable green corridors for wildlife.

This guidance strongly encourages developers to integrate biodiversity within SuDS and explore innovative ways to create new habitats where appropriate.

See also:

Further ecological principles that should be followed: Section 3.5 of The SuDS Manual (CIRIA, 2007)

SuDS provide opportunities to create a variety of important habitats for wildlife due to the need to alter landform, provide open water and create associated terrestrial vegetation. All of these can provide new nesting and foraging or feeding opportunities for birds, amphibians, reptiles, mammals and invertebrates. Furthermore, these features will often provide increased opportunities for people to experience wildlife in close proximity of their homes. For example, the pleasure in watching and listening to song birds is a very rich experience for residents in built-up areas adding quality to people’s lives, and there is an increasing body of evidence which demonstrates the socio-economic value of wildlife collectively referred to as ‘ecosystem services’.

There are a number of simple principles to consider during the development and the implementation of SuDS to ensure existing

wildlife is protected, and that biodiversity is integrated effectively in to the scheme design.

The wildlife value of existing wetland habitats and surrounding terrestrial areas should be surveyed by a suitably qualified/ experienced ecologist during the early planning stages:

- Particular attention should be given to protected species and sites; and ‘habitats and species of principal importance’
- Appropriate information is likely to have been generated as part of any associated planning application/permission
- Hydrological surveys of the area should be undertaken to ensure natural waterflow, above and below the ground, will not be affected either by changes in water quantity or quality.

Where appropriate, the design should:

- Ensure adequate protection for existing aquatic habitats from flooding events
- Locate SuDS features close to, but not directly connected to, existing wetland areas, so plants and animals can naturally colonise the new SuDS ponds
- Create well vegetated shallow bays and establish areas of marsh

- Avoid smoothly finished surfaces; although they give the impression of tidiness, they provide less physical habitat diversity for plants and animals
- If planting is essential ensure only native plants of local origin are used.

To assist ECC and other partners with the delivery of its NERC Act duty, the Essex Biodiversity Project publishes an Essex Biodiversity Action Plan (EBAP) which sets-out those habitats considered a priority for nature conservation action. Developers are encouraged to reflect these priorities in the design of their SuDS, thereby maximising the contribution they can make to halting the loss of biodiversity in Essex.

The Essex Biodiversity Project can provide advice and information on BAP habitats, and further information can be found on their website.

Further detailed advice about integrating biodiversity in to SuDS can also be obtained from suitably qualified/experienced consultant ecologists .

There is a considerable volume of published information and guidance available to developers in relation to biodiversity and SuDS, this guide does not propose to replicate all of

this information and we have signposted the reader to appropriate references throughout the document.

See also:

Further information on ecosystem services: www.ecosystemservices.org.uk

Further information on the Essex Biodiversity Project: www.essexbiodiversity.org.uk

The following local projects for more general guidance:

Water for Wildlife Project: www.essexwt.org.uk/protecting_wildlife/water_for_wildlife

Essex Wildlife Sites Project: www.localwildlifesites.org.uk

General

- Ensure strong connections for wildlife between SuDS features themselves and existing habitat
- Low productivity soils will encourage more diverse vegetation and nutrient rich topsoil should be avoided where possible
- Aim for a succession of flowering and fruiting periods throughout the year and across the site



Within the site

Swales, infiltration and detention basins can provide excellent habitat for invertebrates and birds. Key design considerations include:

- Can be sown with species rich grassland and wildflower mixes and cut for hay
- Combined with foraging and feeding opportunities, microtopography can be manipulated to create areas where wildlife can bask, dig holes, nest and shield themselves from winds
- South facing slopes and friable soils make excellent habitat and should be maximised
- Wooded areas and pockets of scrub can be included in the design of larger infiltration basins

Ponds can provide habitat for a vast array of life including amphibians and birds. Design considerations include:

- Complex, shallow, vegetated edges with large drawdown zones make the best habitat
- Amphibians require landscape features nearby which can be used for foraging and cover e.g hedges, rough grass, rocks
- Avoid planting and allow features to colonize naturally where this is acceptable to site users
- If planting is necessary, a list of suitable species for the area can be provided

Outside the site

Larger SuDS features downstream of the site can be designed to include locally and nationally important habitat types such as fens, wet woodlands and reedbeds. Design considerations include:

- Scope for deeper water, islands and mud for wildfowl and wading birds
- Design and zone to include areas for recreation and areas which are disturbance free for wildlife
- Avoid planting and allow to colonise naturally
- Native plants sourced from local seed sources

At the source

Green and brown roofs can be designed to create disturbance free habitat for invertebrates and birds. Design considerations include:

- Design substrate and planting to increase diversity
- Brown roofs in South Essex could support ground-nesting birds such as the Black Redstart
- Sedum roofs have biodiversity benefits
- Where they hold water from March-May, rain gardens are excellent habitat for frogs, toads and newts and should feature a shallow profile and connections to other nearby habitat

Figure 3.1.1: Opportunities for enhancing SuDS features for wildlife (Cambourne, Cambridgeshire)

LOCAL PRINCIPLE 8: LINK TO WIDER LANDSCAPE

Opportunities to link SuDS to existing or potential future blue and green infrastructure should be explored.

The selection of SuDS types and the creation of the SuDS network should both respond to and inform the surrounding Essex landscape character areas. A landscape-led approach uses SuDS as a mechanism to create strong green and blue infrastructure networks and is important to increase connectivity to the wider ecosystem.

The linear nature of many SuDS can help create green corridors through developments, which is important for wildlife and ensures the associated development is connected with its surrounding environment.

Effective integration will also require carefully researched and selected plants, which work to improve the local green infrastructure.

LOCAL PRINCIPLE 9: DESIGN TO BE MAINTAINABLE

Consideration should be given to ease of access and waste generation when designing SuDS.

It is extremely important to bear maintenance requirements for SuDS in mind from the outset. Throughout the process, it should be considered how features can be accessed, who will be responsible for maintaining them and how much it is likely to cost. Good management and design go together.

SuDS must be designed to provide sufficient access for maintenance. In some instances, this will mean careful consideration to the extent of fencing, provision for gates, the location of drop kerbs to provide access for maintenance vehicles and the extent of which permanently wet features may limit crossing. A minimum easement of 3 metres both sides of SuDS features should also be accounted for to allow maintenance vehicles to access SuDS in areas of private land.

When undertaking the maintenance of SuDS, waste will be generated. This will be predominantly grass and other vegetation, and may be managed on site in wildlife piles. There is still a requirement to comply with all

relevant waste management legislation. This is even more pertinent when waste is disposed off site.

SuDS on industrial sites will need to dispose of hazardous waste separately. It is also important to comply with the duty of care requirements of the waste management legislation. This means that silt should only be removed from site by authorised carriers and should be taken to authorised disposal locations.

See also:
Information relating to waste management licences:
www.environment-agency.gov.uk

LOCAL PRINCIPLE 10: USE A PRECAUTIONARY APPROACH

Precautions should be taken in SuDS design to ensure their efficient functioning at all times.

The Environment Agency promotes SuDS but the natural floodplain must be protected and considered in design. Where SuDS are proposed in a fluvial floodplain the SuDS feature may fill up with river flood water when the area floods and will not have capacity to hold the rainfall runoff from the site as originally intended. Some areas of Essex, where land is low lying,

are in the flood plain, and a pragmatic approach to SuDS design needs to be taken where flood risk is carefully considered but the presence of a floodplain should not explicitly exclude the integration of SuDS features for day-to-day water management. SuDS should not be included in areas where water regularly flows or is stored. The following points should be considered:

- The consequences of failure or a blockage within the system must be considered before adoption
- Once overland exceedance flow routes are identified, buildings should be positioned away or protected from potential flow paths
- SuDS should be designed so that they can continue to operate during periods of high groundwater levels
- Generally it is also considered that temporary storage provided by SuDS should empty from full within 24 to 48 hours, allowing for subsequent rainfall events
- When considering the outfall from a site, if discharging into a watercourse, it should be designed to ensure that site runoff will not be influenced by high water levels
- SuDS should be carefully designed where the presence of contaminated soils or contaminated aquifers has been identified

in order to ensure contaminants are not mobilised

- It is important that the relationship with the coast and any possibility of “tide locking” (where fluvial flows can be held back from discharging into the coast and therefore result in inland flooding) are taken into account with the design and siting of any particular SuDS
- Consideration should be given to the presence of existing sources of water to the site such as natural springs or groundwater fed ponds and how water from these sources will be managed and whether they will impact on the SuDS system
- System components should be designed to maximise their adaptive capacity
- An appropriate factor of safety should be applied to the observed infiltration rate to allow for a reduction in effectiveness of infiltration over time
- Details of any temporary measures to protect against flooding and pollution during construction should be provided

See also:

Further principles of good drainage practice: Section 3.2, of The SuDS Manual (CIRIA, 2007) More general guidance can be found in: Designing for exceedance in urban drainage- good practice (CIRIA, 2006)

LOCAL PRINCIPLE 11: HAVE REGARD TO THE HISTORIC ENVIRONMENT

SuDS design and construction should be sensitive and complementary to Essex’s heritage.

A number of principles can be followed when designing SuDS in order to avoid negative impacts on the historic environment and, where possible, to enhance the contribution that SuDS make to the historic character of urban areas.

When creating new SuDS features, it is beneficial to design and place them with regard to both known and potential unrecorded archaeological remains. Provision may need to be made for archaeological desk based assessment and/or appropriate field investigations, the results of which can be used to assist in the design process, and to support the submission of any planning application. Consideration may also need to be given to the wider historic landscape character of the area.

When incorporating historic water bodies into a new SuDS care needs to be taken to reduce and mitigate any negative impacts and provision may also need to be made for appropriate assessments and specialist advice.

Artificial water bodies such as moats and ponds are important features in the historic landscape of the county and may seem an attractive subject for restoration and ecological enhancement as part of a SuDS e.g. through the removal of vegetation and sediment to reveal open water. However, many of these water bodies possess deposits of important historical, archaeological and palaeoecological value and it is important to assess this potential prior to commencing any restoration works that may destroy these remains. If archaeologically significant deposits are present, then appropriate mitigation measures may need to be carried out.

Within designed landscapes, such as historic parks and open spaces, water can be a fundamental element, forming lakes, ornamental water features, ponds, rivers, streams, canals and ditches linked to the wider landscape. Such systems may have been in existence for centuries and be of considerable historic and ecological significance. Existing water bodies need to be conserved and repaired and where possible modifications (e.g. to original shape, form and profile) should be avoided that affect their historic character and ecological interest. When new SuDS features are introduced – for instance ponds, swales and infiltration basins – their positioning, scale and design, including any

associated planting, should aim to be in keeping with the historic character of the designed landscape. Consideration needs to be given to the appearance of detention basins and infiltration basins when they are empty as well as full, and they should be positioned and detailed appropriately. Care needs to be taken to ensure that the maintenance of new SuDS features conserves the character of the historic designed landscape (e.g. regular cutting of bankside vegetation to avoid scrub growth).

**LOCAL PRINCIPLE 12:
SHOW ATTENTION TO DETAIL**

SuDS must be carefully designed using attention to detail to ensure they function as intended.

SuDS should be designed to take account of current and possible future need for utilities. Underground ducting is a useful way of protecting SuDS features from potential future disruption and is particularly useful where non-standard materials are used, such as permeable pavements.

Utilities should be located either under shared service strips or the footway but never in the carriageway. Service or inspection points for utilities should be designed to be respectful of SuDS features. In the example given in Chapter

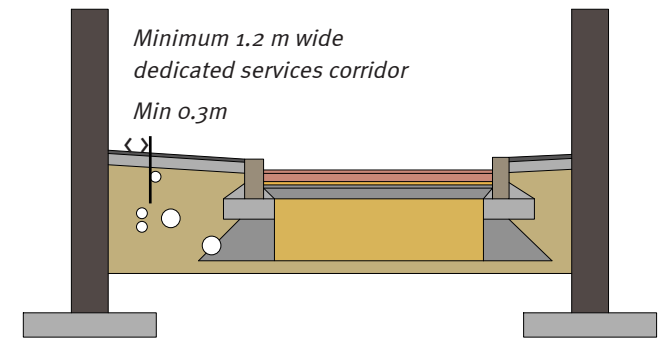

Figure 3.1.2 Services Corridor

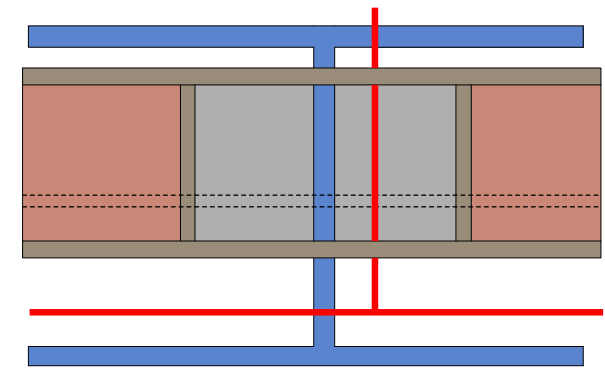
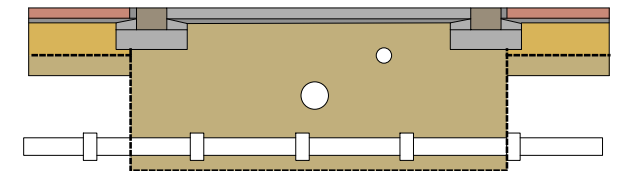

Figure 3.1.3 Delineated Utility Road Crossing (plan)

Figure 3.1.4 (below) Delineated Utility Road Crossing (section)





SuDS service crossing



SuDS Highway detail, Ashford, Kent

4 for the Mews Courtyard, we have given an example of allowance for utilities by providing a 2m band of normal construction paving surrounding permeable paving to provide a conduit for services.

The careful design and construction of levels, selection of materials and design of inlets/outlets is paramount to ensuring the SuDS function as intended. Investing in good design will also ensure that SuDS come together as a whole to deliver all of the desired objectives. If detail cannot be provided upfront it will be a condition of any SuDS permission. Careful consideration to the placing of utilities around SuDS must also be considered to minimise potential disruption through any future upgrading of services. Attention to the detail of SuDS features can also contribute to a development's sense of place. Figures 3.1.2 and 3.1.3 show how the adoption of permeable paving can be integrated with utilities and conventional foul drainage to serve a development.

Utilities within footways in dense urban settings allow the provision of SuDS within the road structure, as shown in Figure 3.1.2 .

Where services crossings are required, particularly in shared surfaces, these may be provided and bounded using flush kerbs and, for example changing the pattern adopted in the block paving or colour of the surfacing to define the extent of the service crossing for future maintenance access, as shown in Figures 3.1.3 and 3.1.4.



Detention basin at 'Lamb Drove', Cambourne

3.2 Local Standards

Our Local Standards are also intended to supplement the National Standards through more aspirational criteria relating to Hydrology and Water Quality (Local Standard 1 & Local Standard 2). We have also set out some Local Standards relating to the design of individual SuDS features.

See also:
The SuDS Manual (CIRIA, 2007)

LOCAL STANDARD 1: DESIGN FOR WATER QUANTITY

SuDS must be designed to ensure that development and occupants are protected from flooding, and that off-site flood risk is not increased. Where possible SuDS should aim to reduce the overall risk of flooding off-site and drain via infiltration as a preference in accordance with the drainage hierarchy contained in Approved Document H of the Building Regulations.

Runoff Rate

Unlike developed areas, greenfield sites generally produce no measurable runoff during small rainfall events (up to 5mm). Receiving streams and rivers are likely to be under greater stress during summer months, with lower available dilution levels reducing their capacity to accommodate polluted inflow. In order to mitigate against this, SuDS should be designed so that runoff does not occur for the first 5mm of any rainfall event for 80% of summer events and 50% of winter events

In all cases, including on brownfield sites, runoff should where possible be restricted to the greenfield 1 in 1 year runoff rate during all events up to and including the 1 in 100 year rainfall event with climate change. If it is

deemed that this is not achievable, evidence must be provided and developers should still seek to achieve no increase in runoff from greenfield sites and a 50% betterment of existing run off rates on brownfield sites (provided this does not result in a runoff rate less than greenfield). If a Surface Water Management Plan has been produced for the area, it may set out further advice on allowable runoff rates.

Storage Volume

When planning the layout of SuDS, sites should take into account topography and make best use of low points for storage.

For rainfall events with a return-period up to and including the 1 in 100 year rainfall event with an allowance for climate change SuDS should be sized to contain all surface water volumes. Applications should demonstrate how this will be achieved, unless otherwise planned and approved by the LLFA SuDs Team. However, if this is not possible, drainage designers must demonstrate how additional flows will be managed.

Unless sufficient pre-treatment has been provided, certain SuDS features may require the incorporation of a sediment forebay to capture sediment to ensure the feature doesn't

silt up and that maintenance activities for sediment removal can be more easily undertaken. Sediment forebays should provide an additional 10% attenuation volume to allow for a level of silting up to ensure this doesn't result in a reduction to the available storage volume.

Safe conveyance routes and overflow flood storage areas must be established and agreed with the SuDs Team for the 1 in 100 year rainfall event with 30% allowance for climate change before adoption.

If runoff cannot be restricted to the greenfield 1 in 1 year event for all events we would expect Long Term Storage to be provided to achieve the same result. The runoff volume should be calculated from all areas of the site, including those remaining permeable, as they will be subject to climate change which may result in measurable runoff. The aim of long term storage is to ensure that any volumes leaving the site above the greenfield runoff volume discharge at 2l/s/ha.

LOCAL STANDARD 2: DESIGN FOR WATER QUALITY

The level of pollution found within surface water runoff will depend on the nature of the development from which it arises, the time

since the last rainfall event and the duration and intensity of rainfall.

An appropriate 'train' of SuDS components must be installed to reduce the risk of pollutants entering watercourses via runoff from developed sites. Following the SuDS Management Train hierarchy a series of drainage techniques should be designed into the development layout. The design should achieve a system where pollution is incrementally reduced at each stage.

Treatment options to address pollution issues include:

- Infiltration
- Filtration
- Detention basins/ponds
- Permanent ponds.

These options reduce pollution by either filtering out pollutants or reducing flow rates to encourage deposition of any contaminants. Polluted surface water runoff should not run directly into permanent ponds in order to protect biodiversity and amenity, and to prevent maintenance problems caused by heavy silts and oil.

The number of treatment stages required within the SuDS train will depend on the nature of the site.



Source of Runoff	Treatment Stages*
Roofs, playing fields	1
Residential roads, parking areas, commercial zones	2
Waste and industrial sites, loadings bays and HGV parks	3 or more



*May need to be increased if discharging to sensitive groundwater/watercourse



Before adopting SuDS it must be demonstrated that the proposed scheme has followed the SuDS Management Train hierarchy and includes the appropriate number of treatment stages.

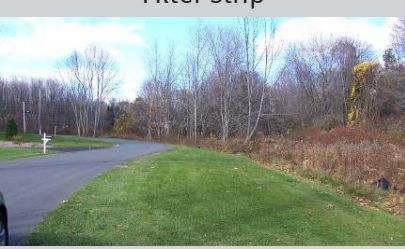

See also:
Detailed guidance on the SuDS management train: Section 1.3.2 and 3.3 of The SuDS Manual (CIRIA, 2007)



Local Standards (cont.)

SuDS Technique	Description and Key Design Points
<p data-bbox="309 300 452 322">Green roofs</p> 	<p data-bbox="609 331 2047 395">A multi-layered system that covers the roof of a building with vegetation/landscaping/permeable car parking, over a drainage layer. These features will not be considered for adoption by the SuDS Team.</p> <p data-bbox="609 437 1102 469">Local Standard 3: Design of green roofs</p> <ul data-bbox="609 475 1236 609" style="list-style-type: none"> • Designed for interception storage • Minimum roof pitch of 1 in 80, maximum 1 in 3 • Multiple outlets to reduce risk from blockages • Lightweight soil and appropriate vegetation.
<p data-bbox="309 657 452 679">Soakaways</p> 	<p data-bbox="609 689 2047 753">Square or circular excavations, filled with aggregate or lined with brickwork, or pre-cast storage structures surrounded by granular backfill.</p> <p data-bbox="609 794 1102 826">Local Standard 4: Design of soakaways</p> <ul data-bbox="609 833 1505 1002" style="list-style-type: none"> • Should be designed for the 1 in 100 year rainfall event as a minimum • Infiltration testing carried out in accordance with BRE Digest 365 • Fill material should provide >30% void space • Base of soakaway at least 1m from groundwater level • Minimum of 5m away from foundations.
<p data-bbox="309 1056 452 1078">Filter strip</p> 	<p data-bbox="609 1104 1393 1136">Vegetated strips of land designed to accept overland sheet flow</p> <p data-bbox="609 1184 1102 1216">Local Standard 5: Design of filter strips</p> <ul data-bbox="609 1222 1339 1327" style="list-style-type: none"> • Recommended minimum width of 6m • Runoff must be evenly distributed across the filter strip • Slopes not exceeding 1 in 20, minimum of 1 in 50.

SuDS Technique	Description and Key Design Points
<p data-bbox="257 295 575 323">Filter trenches and drains</p> 	<p data-bbox="651 331 1684 360">Shallow excavations filled with stone to create temporary surface water attenuation.</p> <p data-bbox="651 400 1312 429">Local Standard 6: Design of filter trenches and drains</p> <ul data-bbox="651 438 1854 571" style="list-style-type: none"> • Excavated trench 1-2m depth filled with stone aggregate • Effective upstream pre-treatment to remove sediment and fine silts • Infiltration should not be used where groundwater is vulnerable or to drain pollution hotspots • Observation wells and/or access points for maintenance of perforated pipe components.
<p data-bbox="376 639 456 668">Swale</p> 	<p data-bbox="651 673 2078 735">Linear vegetated features in which surface water can be stored or conveyed. Can be designed to allow infiltration where appropriate.</p> <p data-bbox="651 775 1081 804">Local Standard 7: Design of swales</p> <ul data-bbox="651 813 1424 914" style="list-style-type: none"> • Limit velocities during extreme events to 1-2 m/s • Maximum side slopes of 1 in 3, where soil conditions allow • Minimum base width of 0.5m.
<p data-bbox="338 979 495 1008">Bioretention</p> 	<p data-bbox="651 1013 2069 1075">Shallow landscaped depressions or pre-cast units which rely on engineered soil and vegetation to remove pollution and reduce runoff.</p> <p data-bbox="651 1117 1155 1145">Local Standard 8: Design of bioretention</p> <ul data-bbox="651 1155 2085 1321" style="list-style-type: none"> • Sufficient area to temporarily store the water quality treatment volume • The water quality treatment event should half drain within 24 hrs to provide adequate capacity for multi-event scenarios • Minimum depth to groundwater of 1m, if unlined • Overflow/bypass facilities for extreme events.

SuDS Technique	Description and Key Design Points
<p>Pervious pavement</p> 	<p>Permeable surface allowing rainwater to infiltrate through into underlying layer where it is temporarily stored.</p> <p>Local Standard 9: Design of pervious paving</p> <ul style="list-style-type: none"> • Pervious sub-base to be structurally designed for site purpose • Temporary sub-surface storage must provide infiltration and/or controlled discharge • Geotextile may be specified to provide filtration treatment • Surface infiltration rate should be an order of magnitude greater than the design rainfall intensity.
<p>Geocellular structures</p> 	<p>Modular geocellular systems with a high void ratio that can be used to create below ground infiltration (soakaway) or storage device.</p> <p>Local Standard 10: Design of geocellular structures</p> <ul style="list-style-type: none"> • Standard storage design using limiting discharges to determine storage volume • Structural design should be to relevant standards for appropriate surface loadings • Use appropriate geotextile (for infiltration) or geomembrane (for storage).
<p>Infiltration basins</p> 	<p>Vegetated depressions designed to store runoff and allow infiltration gradually into the ground.</p> <p>Local Standard 11: Design of infiltration basins</p> <ul style="list-style-type: none"> • Pre-treatment is required to remove sediments and fine silts • Infiltration should not be used where groundwater is vulnerable or to drain pollution hotspots.

SuDS Technique	Description and Key Design Points
<p data-bbox="309 300 519 323">Detention basins</p> 	<p data-bbox="647 331 2074 395">Surface storage basins that provide attenuation of stormwater runoff and facilitate settling of particulate pollutants. They are normally dry and may also function as a recreational facility.</p> <p data-bbox="647 440 1218 464">Local Standard 12: Design of detention basins</p> <ul data-bbox="647 480 1711 539" style="list-style-type: none"> • Maximum side slopes of 1:4 • Bioretention and/or wetland/micropools at outlets for enhanced pollution control.
<p data-bbox="376 635 452 659">Ponds</p> 	<p data-bbox="647 667 2074 730">Provide stormwater attenuation and treatment. Permanent pools to support aquatic vegetation and retention time promotes sediment removal.</p> <p data-bbox="647 775 1084 799">Local Standard 13: Design of ponds</p> <ul data-bbox="647 815 1856 906" style="list-style-type: none"> • Permanent pool for water quality treatment and temporary storage volume for flow attenuation • Minimum depth for open water areas of 1.2m • Maximum side slopes of 1:3.
<p data-bbox="353 986 474 1010">Wetlands</p> 	<p data-bbox="647 1018 2051 1082">Shallow ponds and marshy areas for attenuation and water treatment. Aquatic vegetation and extended detention allow sediments to settle.</p> <p data-bbox="647 1126 1122 1150">Local Standard 11: Design of wetlands</p> <ul data-bbox="647 1166 1464 1289" style="list-style-type: none"> • Shallow, temporary storage for attenuation • Sediment forebay or equivalent upstream pre-treatment • Combination of deep and shallow areas (maximum depth <2m) • Length:width ratio of greater than 3:1, shallow side slopes.

SuDS Technique	Description and Key Design Points
<p>Rainwater harvesting</p> 	<p>Rainwater harvesting is the process of collecting and using rainwater. If designed appropriately the systems can be used to reduce the rates and volumes of runoff (for more information see Appendix 1).</p> <p>Local Standard 12: Design of rainwater harvesting</p> <ul style="list-style-type: none"> • Can range from complex district-wide systems to simple household systems linked to a water butt • Most simple rainwater harvesting systems are relatively easy to manage • Rainwater harvesting systems can be combined with grey water recycling systems to form an integrated process.
<p>Greywater recycling</p> 	<p>Greywater recycling is the re-use of waste water collected from showers, baths, washbasins, washing machines and kitchen sinks (for more information see Appendix 1).</p> <p>Local Standard 13: Design of greywater recycling</p> <ul style="list-style-type: none"> • Common features include a tank for storing water, a pump, a distribution system and, where it is needed, some sort of treatment • Greywater stored for any length of time has to be treated as otherwise it deteriorates rapidly.

4.0 DESIGNING SUDS

4.0 DESIGNING SuDS

The purpose of this section is to focus upon the principles and processes of designing SuDS. Ideas, issues and opportunities are illustrated through a series of case studies and design examples.

Introduction

The SuDS ponds and wetlands at Augustenborg in Malmo have not only been designed to store and treat run-off but also to enhance the landscape setting of people's homes and provide habitat for wildlife. At Ravenswood in Ipswich, the native vegetation and undulating topography of infiltration basins creates an exciting and dynamic network of open spaces for residents. The green roof at Sharrow School in Sheffield attenuates run off, provides an educational resource and was recently designated a Local Nature Reserve. These and an ever-growing number of other schemes demonstrate the multiple benefits a more sustainable approach to drainage can bring.

Unlike conventional piped drainage, SuDS store and treat large volumes of water within the site boundary and at the surface. As described above, this can enrich a development and reinforce the landscape character of the wider

area as well as providing an effective and sustainable drainage mechanism. However, keeping water at the surface can potentially bring the drainage system into conflict with other requirements and site users.



The SuDS ponds at Augustenborg in Malmo are integral features of the courtyards

SuDS features must be integrated with roads, parking areas, buildings, open spaces, urban design guidance and requirements for health and safety and utilities. The perceptions of site users should not be underestimated. SuDS make natural processes visible and, if not carefully designed, they can appear messy, uncared for and unsafe.

The characteristics of a site and nature of the

development must also be carefully assessed and will affect the complexity of designing a SuDS system. A low density residential scheme on a gently sloping greenfield site with sandy soils will pose less physical constraints to a SuDS scheme than a high density scheme on steep brownfield land with clay soils.



Sheffield's latest Local Nature Reserve (Sheffield City Council, 2010)

In practice, reconciling these multiple considerations can be very challenging but the range of SuDS techniques (see section 3.0) is vast and solutions can be found. Permeable paving is traffickable and can be designed to manage run off from large areas. Rain gardens and ponds can be integrated and linked together to create a valuable series of open spaces. Larger wetland areas can be integrated within designated public open space.

The following sections explore the issues and opportunities for SuDS in Essex and how SuDS can be integrated with other requirements in practice.

4.1 The Planning and Design Process

A sustainable drainage solution must be tailored to the unique characteristics of the site, design criteria and the nature of the development. Topography, soil types, existing features and the specific requirements of the development are just some of the factors that will shape the final design.

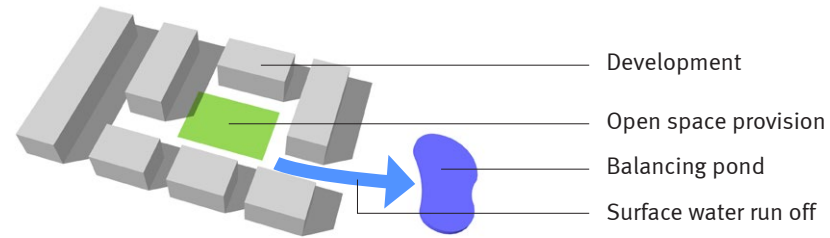

Figure 4.1.1 Large stand-alone balancing ponds are not the only solution

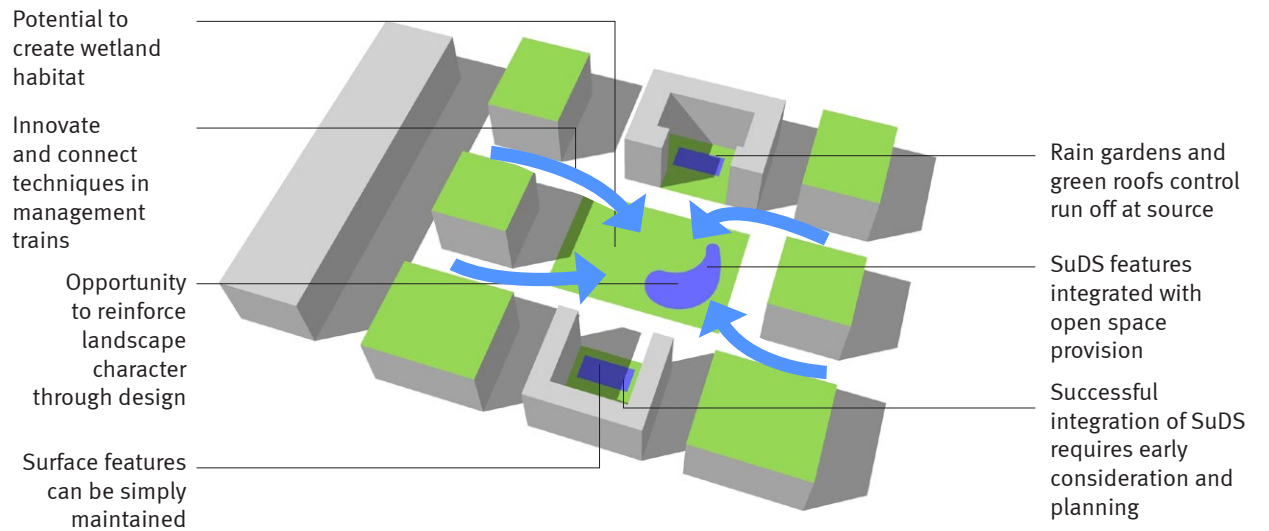

Figure 4.1.2: An integrated approach to surface water management

The following series of diagrams have been adapted from section 4.0 of Planning for SuDS (CIRIA, 2010). They illustrate how SuDS design can be integrated within the planning process and influence the layout of developments.

Key to figures:

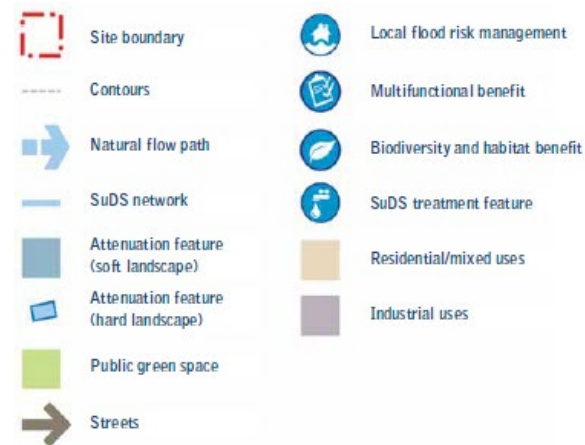

Figure 4.1.3 SuDS Planning Process (CIRIA, 2010)

1: Examine site topography and geology

- Aim to mimic the natural drainage systems and processes as far as possible
- Identify key natural flow paths and potential infiltration areas to understand opportunities and constraints.



Figure 4.1.4 SuDS Planning Process (CIRIA, 2010)

2: Create a spatial framework for SuDS

- Minimise run-off by rationalising large paved areas and maximising permeable surfaces
- Consider likely space needs for site control SuDS based on character of the development and the proposed degree of source control
- Use flow paths and possible infiltration or storage areas to inform development layout.



Figure 4.1.5 SuDS Planning Process (CIRIA, 2010)

3: Look for multi-functional spaces

- Consider how SuDS features could be co-located with open space and public realm areas to create multi-functional spaces
- SuDS can be designed to be valuable amenity and ecological features.



Figure 4.1.6 SuDS Planning Process (CIRIA, 2010)

4: Integrate with the street network with SuDS

- Structure the street network to complement and manage flow pathways
- Integrate SuDS features into street cross-sections, ensuring street widths are adequate
- SuDS should be used to improve the streetscape providing amenity and multifunctionality by integrating with other street features including tree planting, traffic calming, parking bays, verges and central reservations.



Figure 4.1.7 SuDS Planning Process (CIRIA, 2010)

5: Cluster land uses to manage pollution

- The number, size and type of SuDS will be affected by land uses and the corresponding pollution risk
- Potential polluters, e.g industrial developments, should have their own isolated SuDS network
- Integrate a series of SuDS features that will provide water treatment throughout the networks responding to the level of pollution risk
- Clustering should be considered alongside other mixed use ambitions.

4.2 Design Examples

The following examples of possible SuDS schemes relate to actual places (many of which are in Essex) and their design has therefore been influenced by local constraints and opportunities, which developers are likely to encounter. They are intended to illustrate some of the provisions of this guidance and demonstrate as many issues as possible.

Of course, each plan depicts just one possible solution for an individual site. There is no one size fits all with SuDS and the purpose of this section is to encourage an innovative and integrated approach to sustainable drainage, which is informed by site characteristics and development proposals. Rather than repeat existing guidance, the text includes references and electronic links for key sources of further details and information.

Conceptual design proposals for each scheme were developed by a multi-disciplinary team. The design process was adapted from The SuDS Manual (CIRIA, 2007) and is illustrated by the adjacent flowchart.

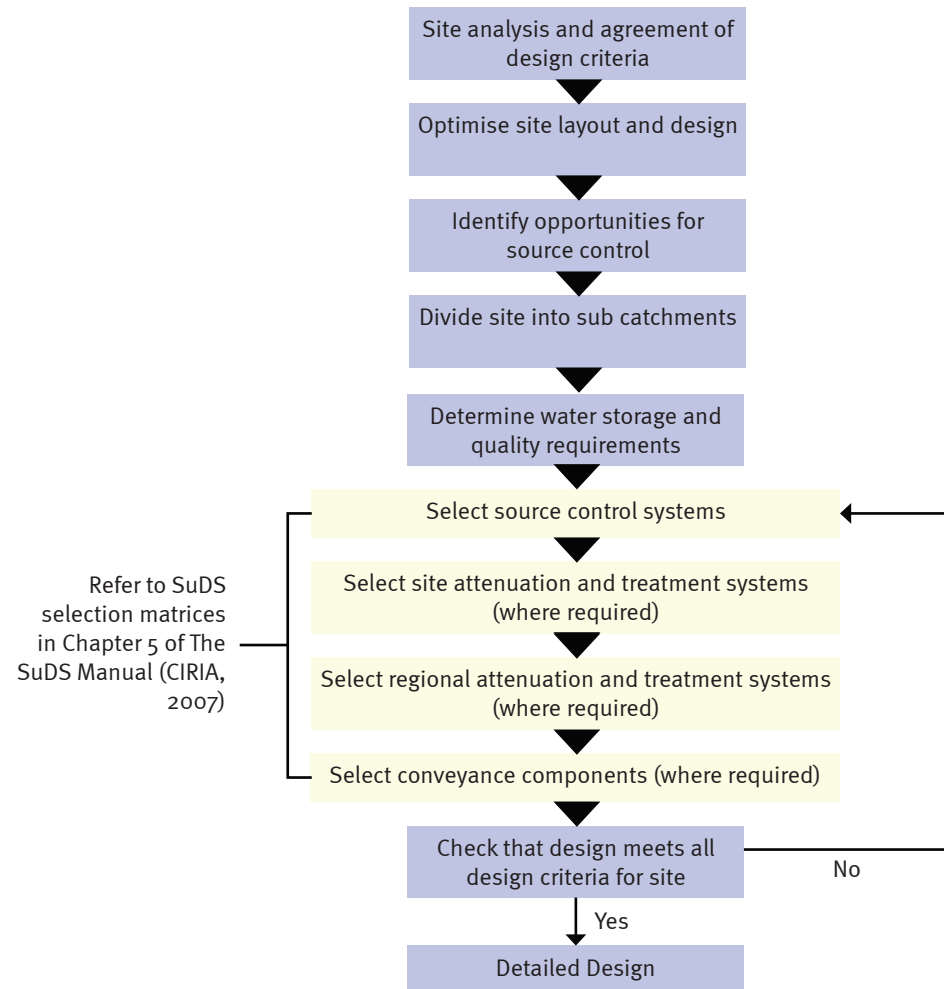

Figure 4.2.1 SuDS Selection Flowchart (adapted from CIRIA, 2007)

4.2.1 Mews Courtyard

Site Area: 0.2 Ha

Net Density: 30+ dwellings per hectare

This example looks at how SuDS can be integrated within a mews courtyard. This type of development is typically a mix of two and three storey houses with private gardens, which face onto a central parking court.

The site slopes gently from the north east to the south west and overlays soils of very low permeability. The drainage system for the mews courtyard will need to manage run off from the following areas:

- Roofs
- Parking courts
- Access road
- Driveways.

The opportunities and constraints for SuDS are detailed in the figure opposite. There is space for SuDS features to be incorporated within the design of the courtyard and parking areas as well as scope for green roofs on outbuildings.

Site Characteristics:







Factor	Opportunity/Constraint
Use	Residential - low pollution risk
Soils	Low permeability in this location - no infiltration possible. No contamination
Topography	Gently sloping terrain to south west
Groundwater	Depth less than 1.0m - not suitable for infiltration
Space	Limited space within parking courts due to vehicle movements and parking requirements
Catchment	Receiving watercourse is within a public open space
Maintenance	To be agreed with SuDS Team, water company and Highways
Safety	Eliminate and mitigate residual risk of SuDS features to the health and safety of residents
Ecology	Limited scope for SuDS techniques which create opportunities for wildlife



Mews Development, Black Notley, Essex

Site Analysis:

Key

	Pitched roof	458 m ²
	Outbuilding	130 m ²
	Parking court	735 m ²
	Private garden	750 m ²
	To retention pond	
	Direction of slope	

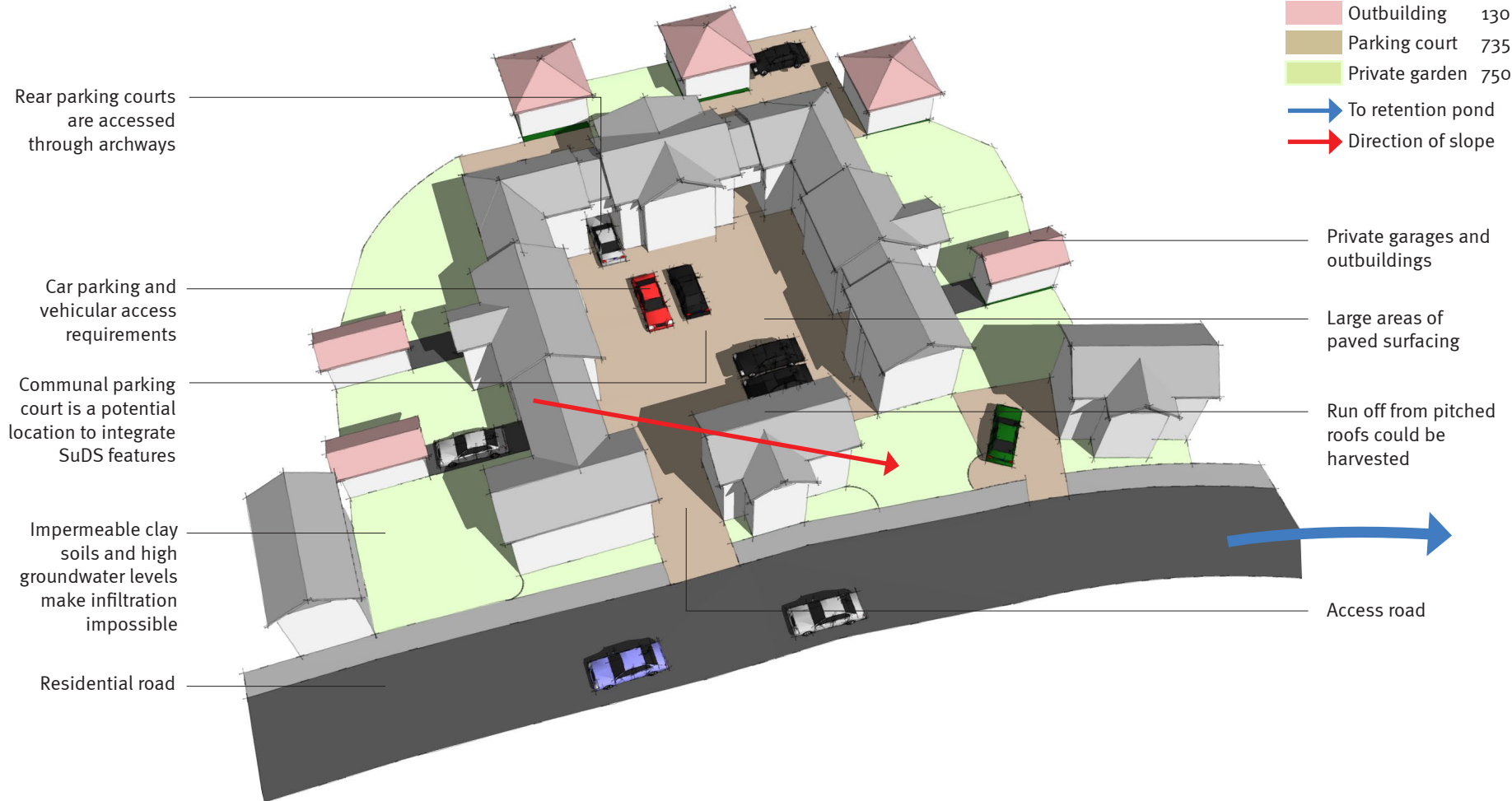

Figure 4.2.1.1: Analysis of proposed development

Setting the design criteria:

Storage

- Provide sufficient storage to cope with the 1 in 30 year rainfall event (Storage for the 1 in 100 year event plus 30% for climate change is provided downstream)
- Discharges from the site are to be limited to greenfield flow rates
- The storage volume required for the 1 in 30 year event is in the region of 25m³.

Quality

- The system must provide one level of treatment for roofs and two levels of treatment for the parking courts.

Amenity

- SuDS features must be integrated with the functional requirements of the courtyard and enhance its appearance.

Biodiversity

- SuDS features should be designed to maximise their value to wildlife.

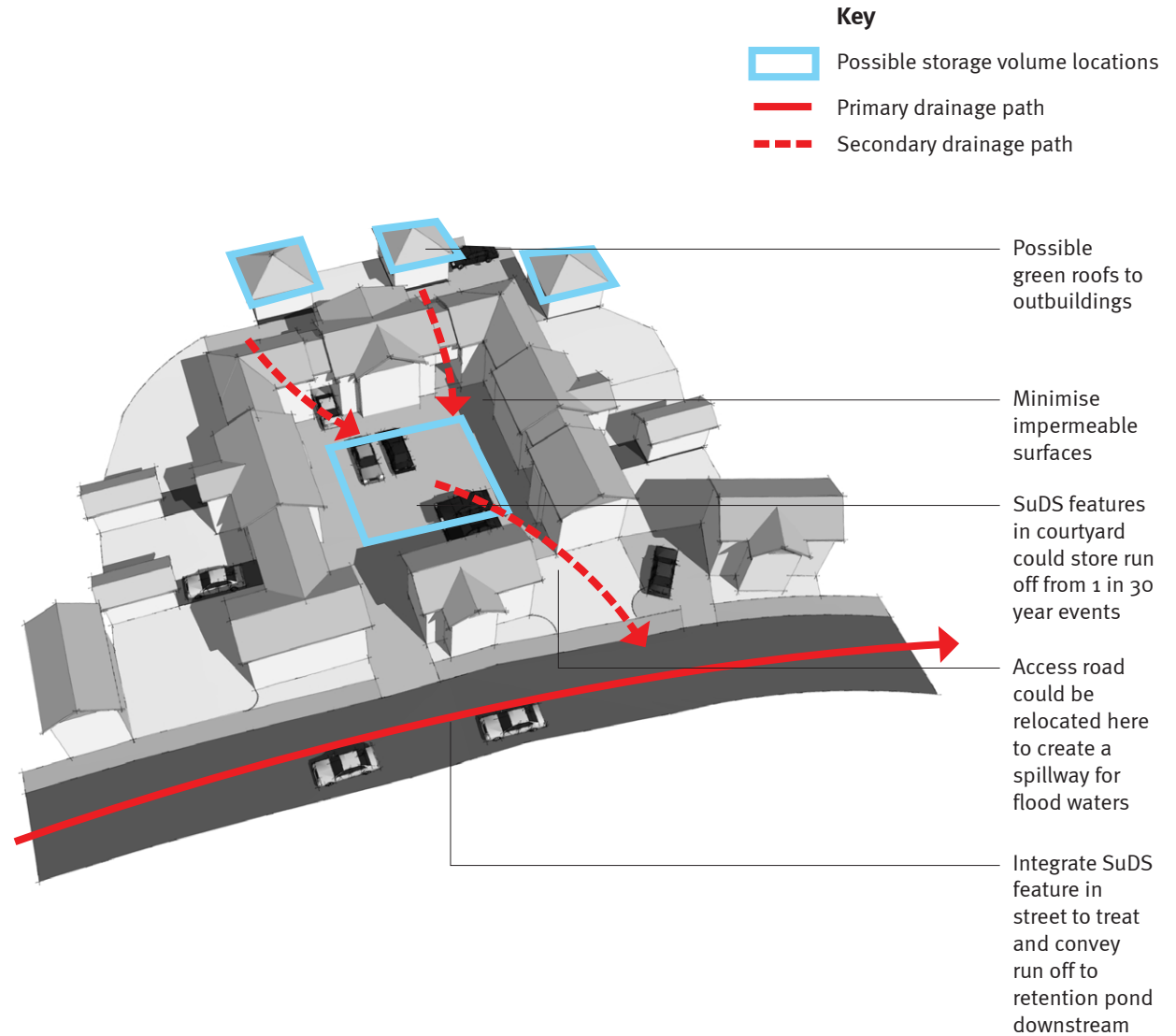

Figure 4.2.1.2: Initial assessment of flow routes and potential storage volumes

Case Study:**Scheme:** Augustenborg Courtyards**Location:** Malmo, Sweden**Techniques:** Ponds, channels and rills

Ekostaden Augustenborg is the collective name for a program to make Augustenborg into a more socially, economically and environmentally sustainable neighbourhood. The storm water system has gone through a major change. Green roofs and open storm water channels leading into ponds have stopped the flooding in the area and have created a beautiful environment and a richer biodiversity.

There are a total of 6 km of canals and water channels in Augustenborg. 90% of the storm water from roofs and hard surfaces is led into the open storm-water system in the housing area. The aim of the project was that 70% of all storm water should be taken care of for the whole of Augustenborg.



Ponds, channels and rills at Augustenborg, Malmo

1. Channel with notch for water to spill out into pond
2. No kerb to allow run off from adjacent paved surface to flow into channel
3. Permanent water body and storage volume
4. Play area forms part of integrated amenity space, in which the SuDS pond is a key feature
5. Outflow with flow control to larger SuDS features downstream
6. Overlooked space using natural surveillance as opposed to fencing off the site

Concept Plan:

- Extensive green roofs on outbuildings treat and attenuate run off
- Permeable paving not included here as it would be difficult to maintain due to the arches
- Downpipes connected to permeable paving sub base in courtyard
- Archways to rear parking courts
- 2.0m* band of normal construction paving provides conduit for services
- Bioretention planters treat and attenuate run off up to the 1 in 30 year event
- Development reconfigured to allow for exceedance and flood route
- Swale conveys stormwater from development plots and highway to retention pond in open space

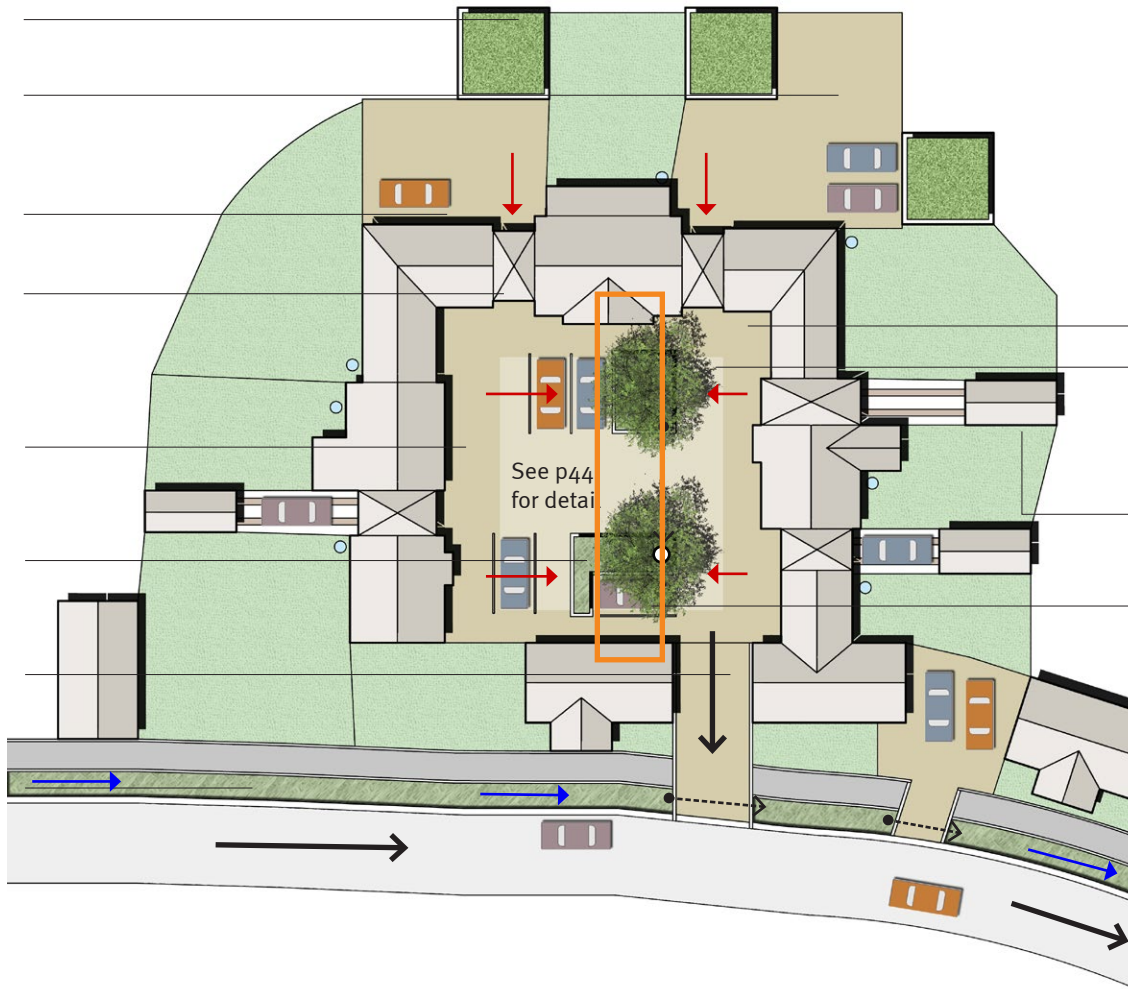

- Key**
- Flow in SuDS
 - Surface flow
 - - - -> Flow in pipe
 - Flood route
 - Outflow pipe to swale
 - Permeable paving
 - Impermeable paving
- Impermeable surface of driveway minimised
 - Permeable paving design to treat the first flush volume before discharging to bioretention planters
 - Water butts connected to downpipe. Overflow is piped downstream
 - Trees intercept rainwater and contribute to the amenity and biodiversity of the site. Potential of falling leaves to affect performance of paving should be assessed and species selected accordingly

* if infiltration proposed beneath permeable paving a 5m band should be provided in accordance with Building Regulations

Figure 4.2.1.3: Conceptual Drainage Solution

Illustrative detail:

- Key**
- Flow in SuDS
 - Surface flow
 - - - - -> Flow in pipe
 - Flood route
 - Outflow pipe to swale

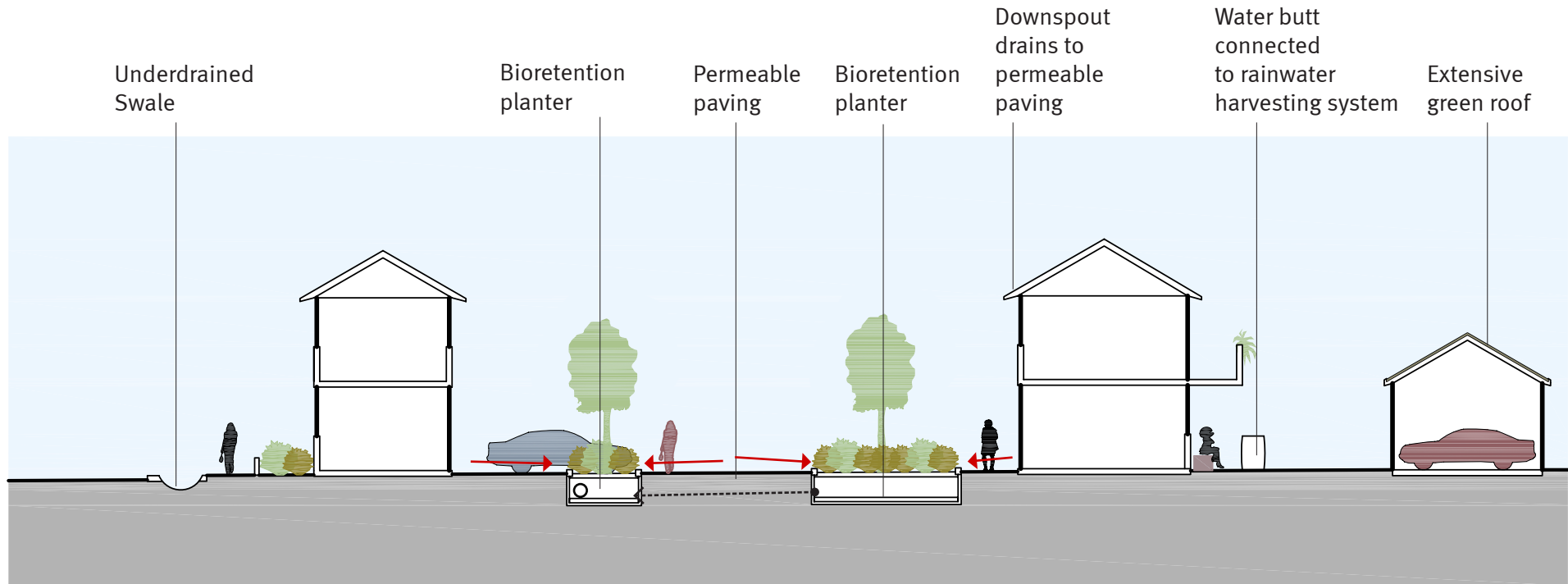

Figure 4.2.1.4: Typical section through mews courtyard

4.2.2 Informal Street

Site Area: 1.25 Ha

Net Density: 20+ dwellings per hectare

An informal street is proposed as part of a larger residential development on a greenfield site, which will drain to an integrated SuDS system. The drainage system for the site will need to manage run off from the following areas:

- Pitched roofs
- Parking courts
- Footpaths and driveways
- Highway.

The soils on site are impermeable clays and there is a gentle slope from west to east. A large public open space lies to the east of the development.

The continuous frontage and dimensions of the street create a strong sense of enclosure. This is a defining principle of the Essex Design Guide. The drainage system should be carefully designed to ensure that SuDS techniques proposed are compatible with this approach.

See also:

Development principles in the Essex Design Guide: www.the-edi.co.uk/essexdesignguide2005.php

Site characteristics:

Factor	Constraint/Opportunity
Use	Residential - low pollution risk
Soils	Mixed - infiltration possible in certain areas
Topography	Gently sloping terrain
Groundwater	Depth less than 2.0m
Space	Less public space than the mews courtyard. It will be necessary to consider how SuDS can be designed into the street
Catchment	Receiving watercourse is vulnerable to pollution
Maintenance	To be agreed with SuDS Team, water company and Highways
Safety	Health and safety of features in the street must be considered
Ecology	Think about SuDS techniques which create opportunities for flora and fauna



Informal street, Great Notley, Essex

Site Analysis:

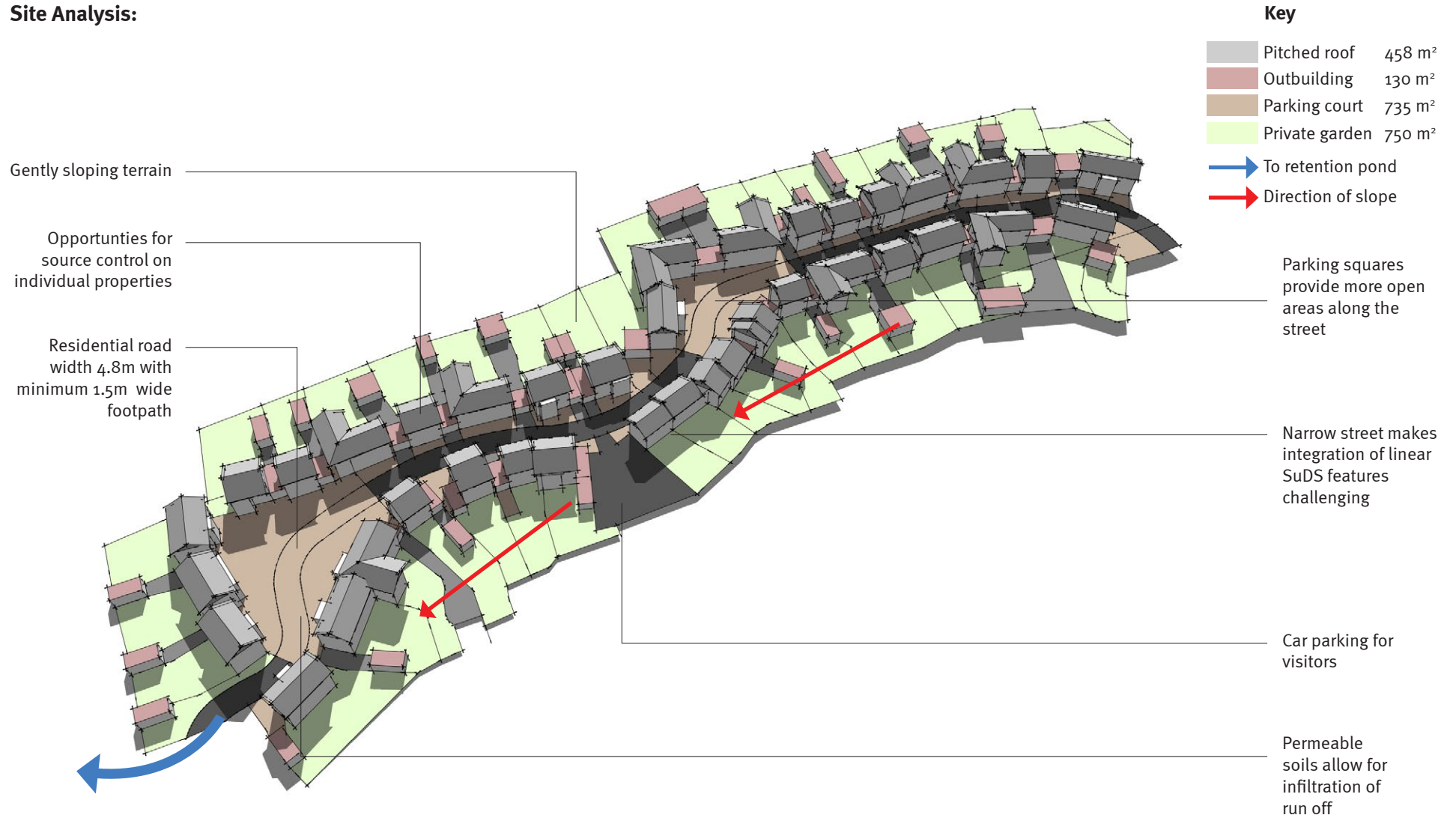

Figure 4.2.2.1: Analysis of proposed development

Setting the design criteria:

Storage

- The design standard for the informal street is to provide sufficient storage to cope with the 1 in 30 year rainfall event
- Discharges from the site are to be limited to greenfield flow rates
- The storage volume required to provide sufficient attenuation of the 1 in 30 year event is in the region of 120m³.

Quality

- The system must provide one level of treatment for roofs and two levels of treatment for the parking courts.

Amenity

- There is an opportunity to create attractive pocket park areas through creative design of SuDS features.

Biodiversity

- Best practice ecological design of SuDS features to maximise biodiversity.

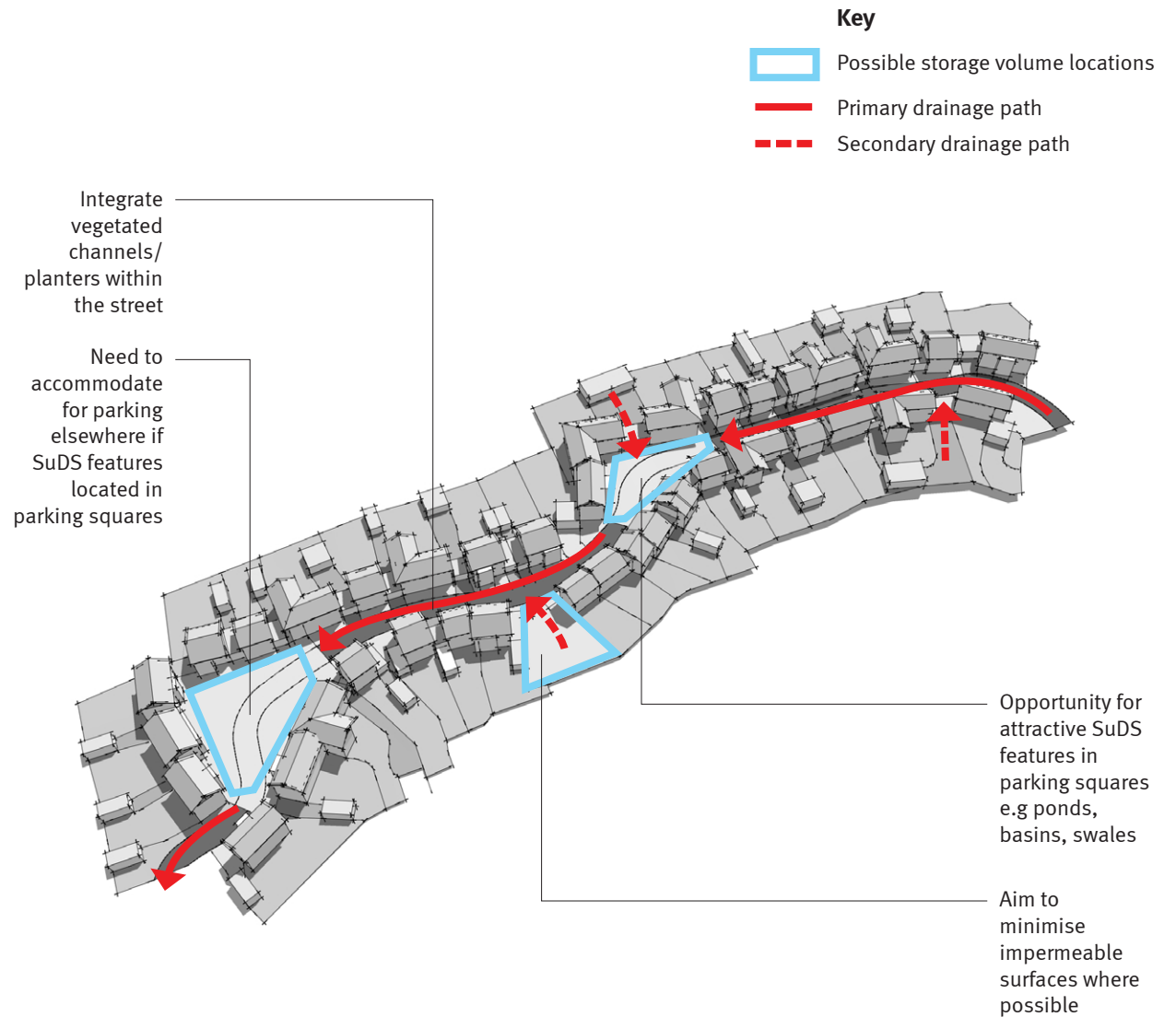

Figure 4.2.2.2: Initial assessment of flow routes and potential storage volumes

Case Study:**Scheme:** Ravenswood**Location:** Ipswich, Suffolk**Techniques:** Infiltration basin

The developers of this housing scheme designed the site so that all surface water run off is drained through a combination of soakaways and infiltration basins. Using SuDS, there is no discharge from the site up to the 1 in 100 year storm - the equivalent of 6600m³ storage.

The SuDS are managed by Ipswich Borough Council using commuted sums as public open space. Over its lifetime, the scheme has the potential to save £600,000 in construction compared to a traditional piped drainage system. Individual homeowners are also eligible for refunds of their sewerage charge.

Houses and driveways are connected to individual soakaways and roads are drained by a piped system that discharges to infiltration basins running along the main boulevards.



Infiltration basin at Ravenswood

1. Grassed base of infiltration basin
2. Vegetated bank, opportunities for play whilst feature is dry
3. Native vegetation and naturalistic aesthetic creates exciting and dynamic landscape feature
4. Natural surveillance of amenity space as opposed to fencing off the facility

Concept Plan:



Figure 4.2.2.3: Conceptual Drainage Solution

Illustrative detail:

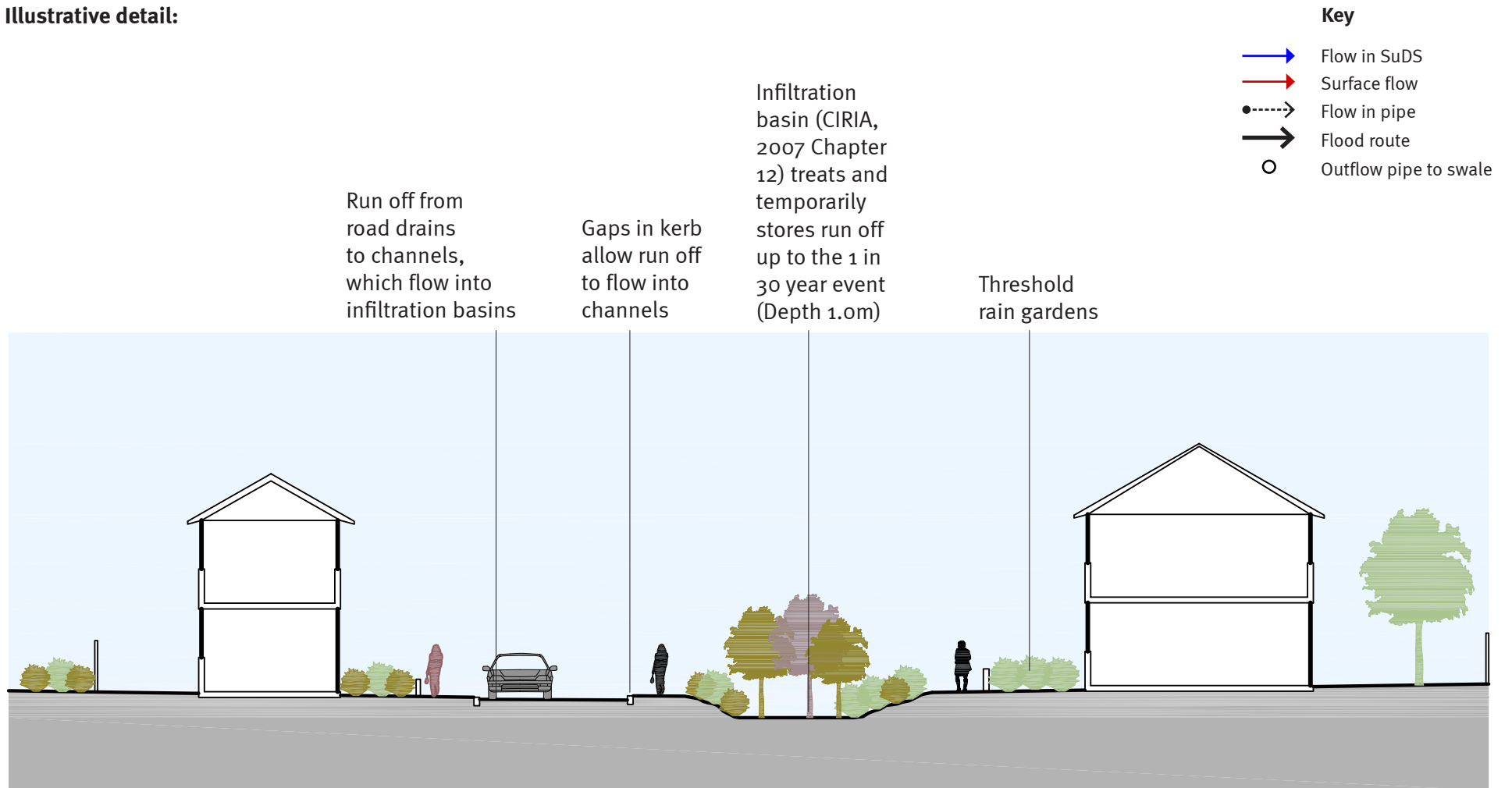

Figure 4.2.2.4: Typical section through street

4.2.3 Mixed Use Street

Density: 75+ dwellings per hectare

This example explores how sustainable drainage techniques can be accommodated within the streets of high density mixed use developments.

The drainage system will need to manage run off from the following areas:

- Roofs
- Road
- Parking bays
- Pavement.

The site is gently sloping. Although it is challenging to integrate SuDS within this type of development, there are a number of SuDS techniques, which can be combined and designed to provide an effective drainage solution as well as enhancing the amenity of the street. Relevant schemes and techniques are highlighted throughout.

Site characteristics:

Factor	Constraint/Opportunity
Use	Mixed - risk will vary according to land use
Soils	Low permeability - no infiltration possible
Topography	Gently sloping valley
Groundwater	Depth greater than 4.0m
Space	Land values are at a premium and pavements and roads
Catchment	A linear public open space is proposed to run through the centre of the development
Maintenance	To be agreed with SuDS Team, water company and Highways
Safety	Eliminate and mitigate residual risk of SuDS features to the health and safety of the public
Ecology	Limited scope for SuDS techniques which create opportunities for wildlife



Mixed Use Street, Brentwood, Essex

Site Analysis:

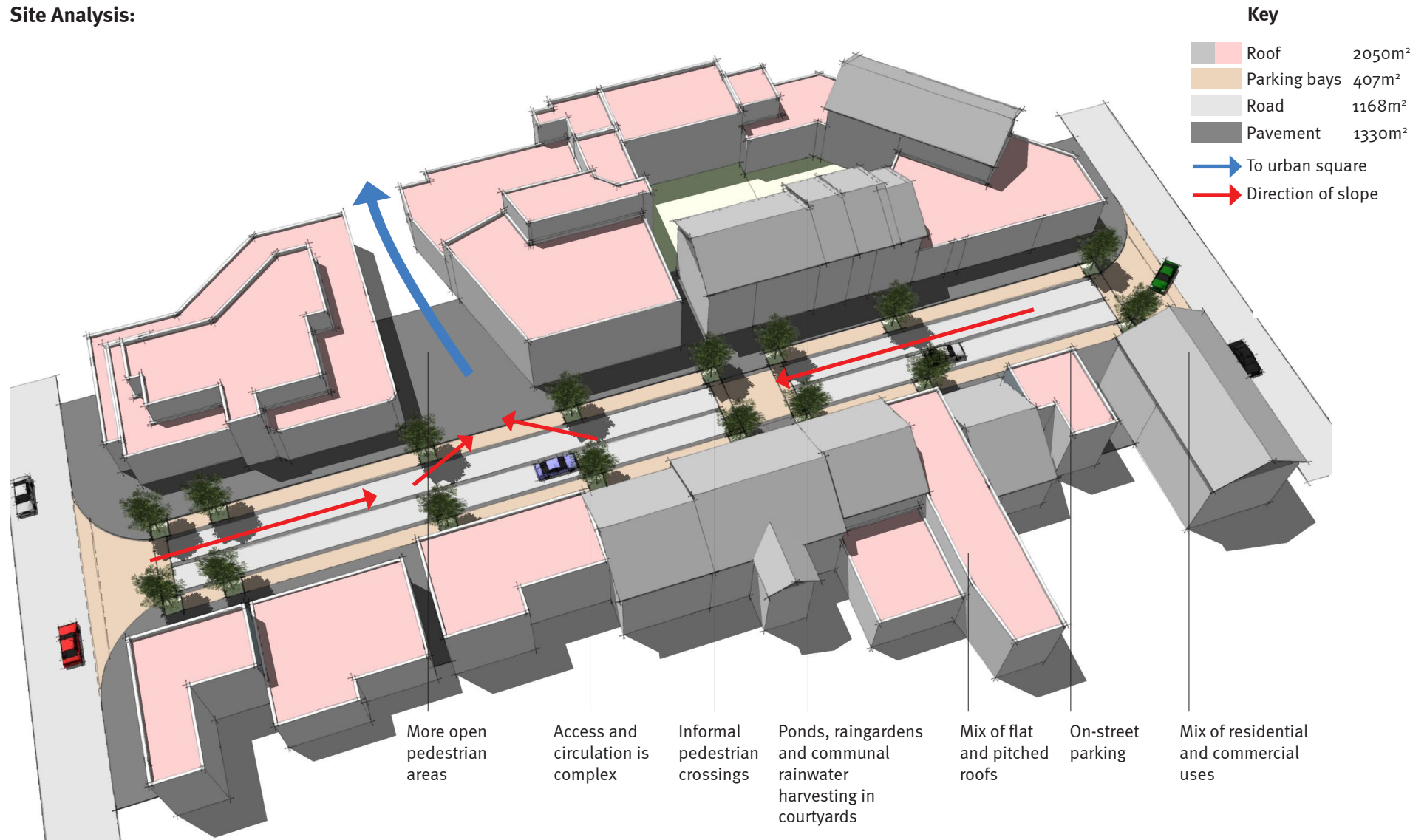

Figure 4.2.3.1: Analysis of proposed development

Setting the design criteria:

Storage

- The design standard for the mixed use street is to provide sufficient storage to cope with frequent rainfall events
- Discharges from the site are to be limited to greenfield flow rates
- The storage volume required to provide sufficient attenuation of the 1 in 30 year event is in the region of 165m³. This increases to 320m³ for the 1 in 100 year event plus 30% for climate change.

Quality

- One level of treatment is required for run off from roofs. Two levels of treatment are required for run off from the road and parking bays.

Amenity

- There is an opportunity to enhance the pedestrian environment through planting.

Biodiversity

- Limited scope for biodiversity.

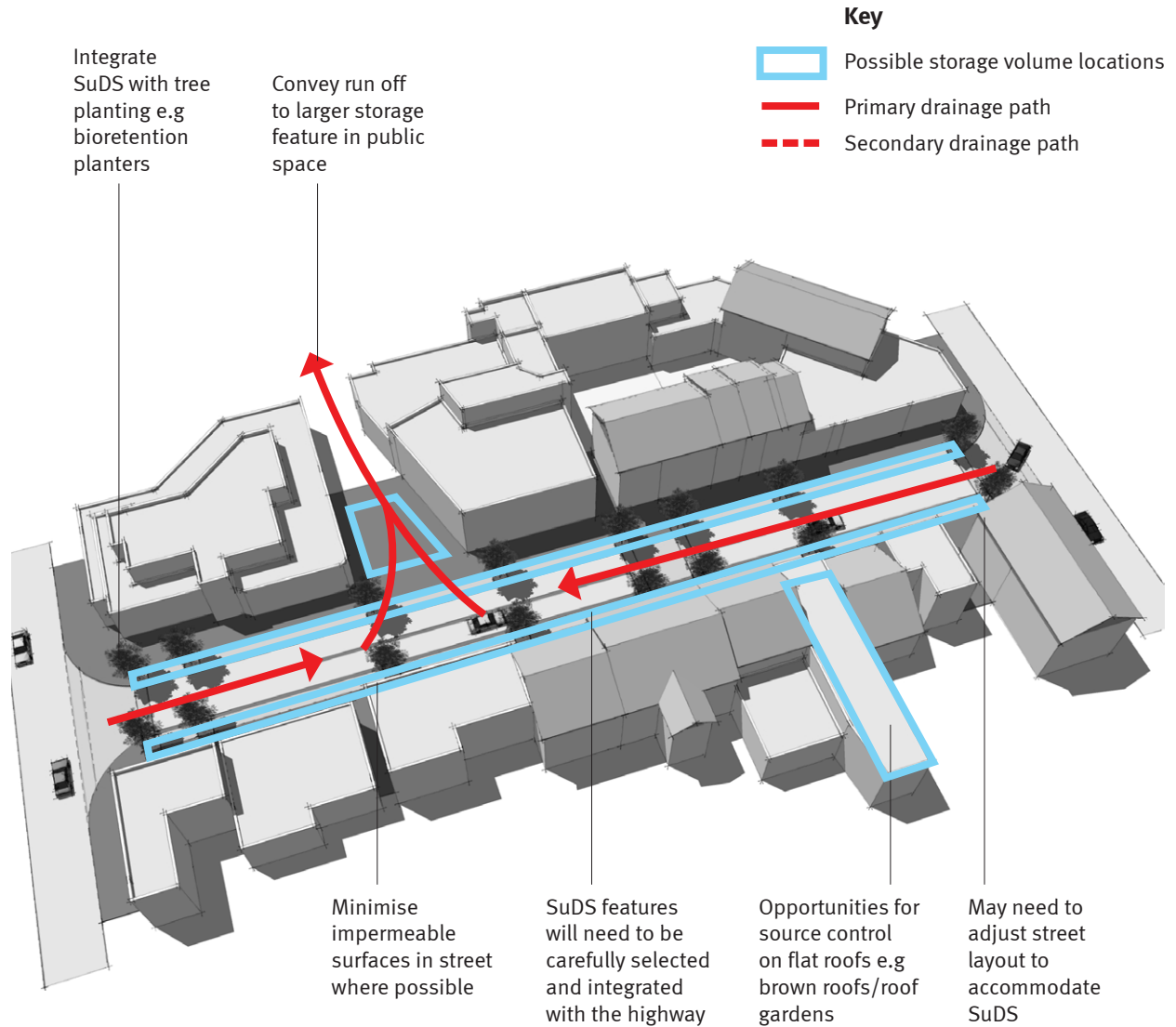

Figure 4.2.3.2: Initial assessment of flow routes and potential storage volumes

Case Study:**Scheme:** Portland Green Streets**Location:** Portland, Oregon, USA**Techniques:** Bioretention planters

Bioretention planters are shallow landscaped depressions, which are typically underdrained and rely on engineered soils and enhanced vegetation and filtration to remove pollution and reduce run off downstream. They are aimed at managing and treating run off from frequent events.

The planters are very flexible and can be adapted to fit into the layout of most types of scheme. They are therefore ideal for the constraints posed by parking and access requirements of residential schemes.



Bioretention planter in Portland

1. Slot in kerb allows run off from adjacent paved surface
2. Inlet from road into forebay
3. Run-off is retained in the planter to a maximum depth of 15cm
4. Outlet to street
5. Footpath allows space for people to safely park and get out of their cars
6. Tree planting contributes to the amenity of the street

Concept Plan:

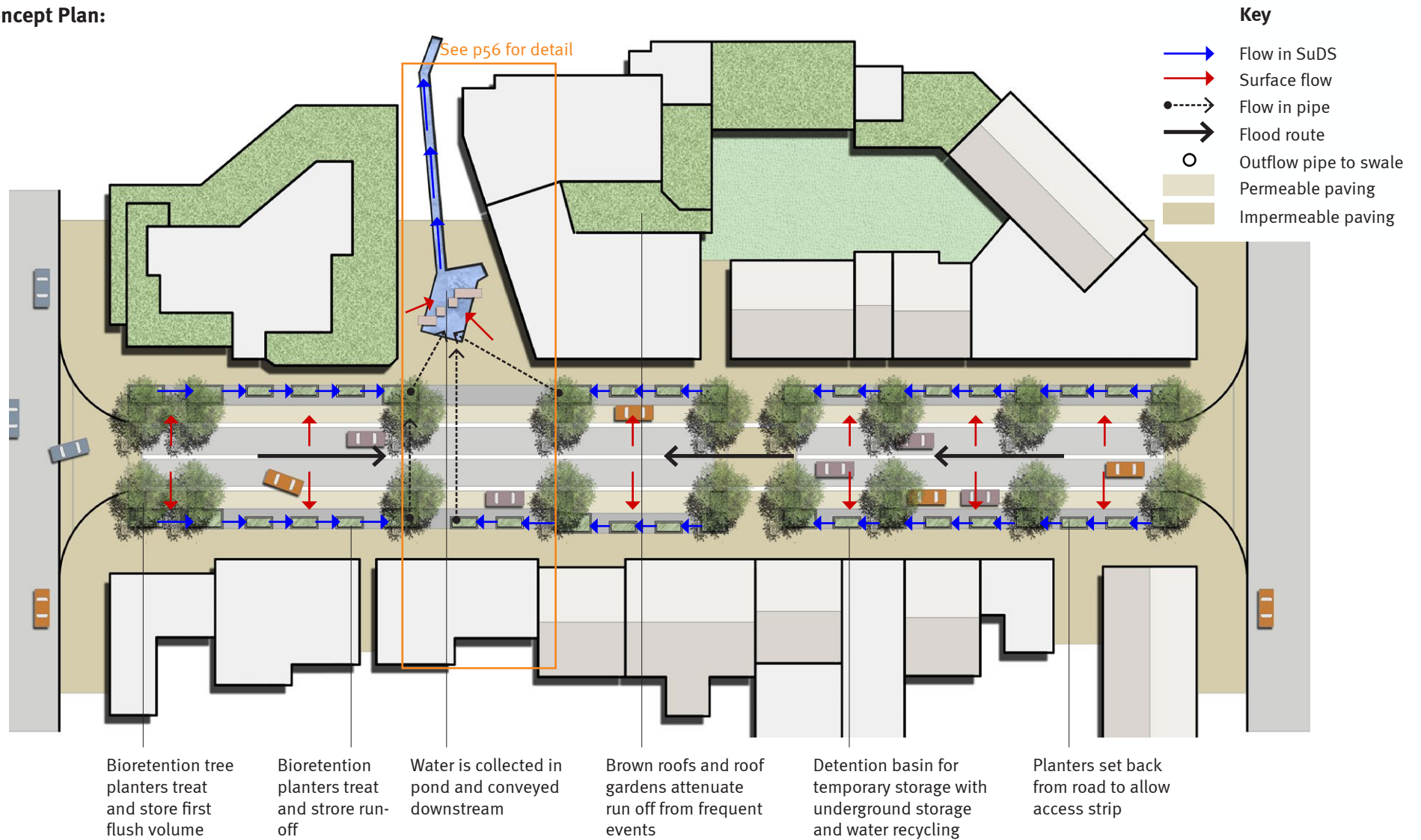

Figure 4.2.3.3: Conceptual Drainage Solution

Illustrative Detail:

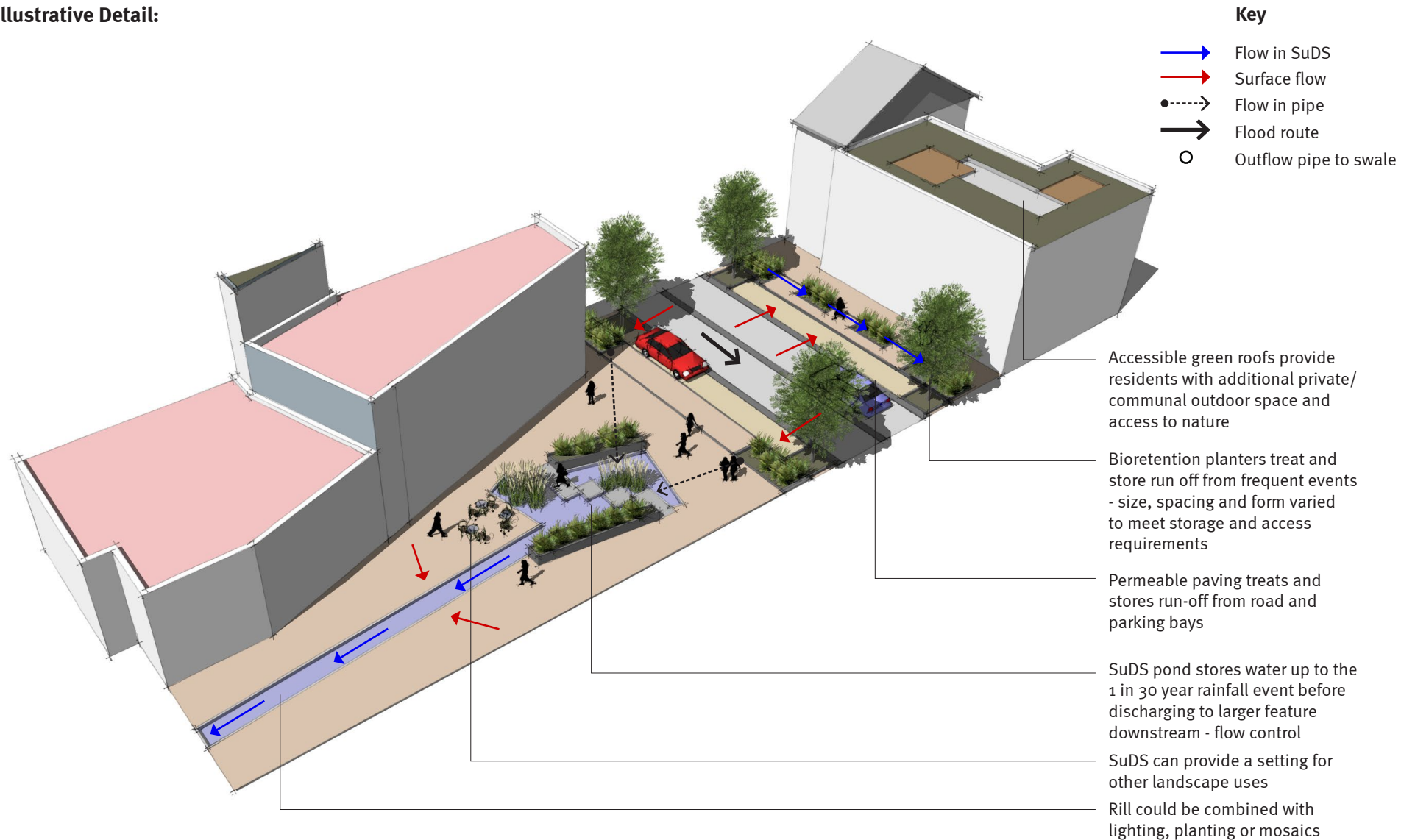

Figure 4.2.3.4: Illustrative detail of street

4.2.4 High Density Neighbourhood

Site Area: 1.5ha
Net Density: 75+ dwellings per hectare

The development proposals include a variety of houses, apartments, business units and shops.

A small urban park is proposed at the centre of the development where children can play unsupervised. The drainage system will need to manage run off from the following areas:

- Pitched roofs
- Parking courts
- Footpaths
- Roads and shared space.

The site lies at the centre of an established neighbourhood in Essex on a busy street corner.

Although the road to the west slopes quite steeply to the north, the site itself has been artificially terraced and slopes gently down towards the River Colne in the east. The soils are thought to be low permeability.

Site characteristics:

Factor	Constraint/Opportunity
Use	Residential - low pollution risk
Soils	Low permeability london clay - no infiltration possible
Topography	Gently sloping terrain
Groundwater	Depth greater than 4.0m
Space	Drainage opportunities in courtyards and public open space
Catchment	River Colne lies to the east
Maintenance	To be agreed with SuDS Team, water company and Highways
Safety	Health and safety of features in the street must be considered
Ecology	Think about SuDS techniques which create opportunities for flora and fauna



High density development, Chelmsford, Essex



Figure 4.2.4.1: Analysis of proposed development

Setting the design criteria:

Storage

- The design standard for the neighbourhood is to provide sufficient storage to cope with the 1 in 100 year rainfall event plus 30% for climate change
- Discharges from the site are to be limited to greenfield flow rates of 5l/s/h
- The storage volume required to provide sufficient attenuation of the 1 in 100 year event plus 30% is in the region of 470m³.

Quality

- One level of treatment is required for run off from roofs. Two levels of treatment are required for run off from the parking courts and road.

Amenity

- Opportunity to enhance development.

Biodiversity

- There is significant scope to create SuDS features within provide habitat for a range of BAP species within the public open space and courtyards.

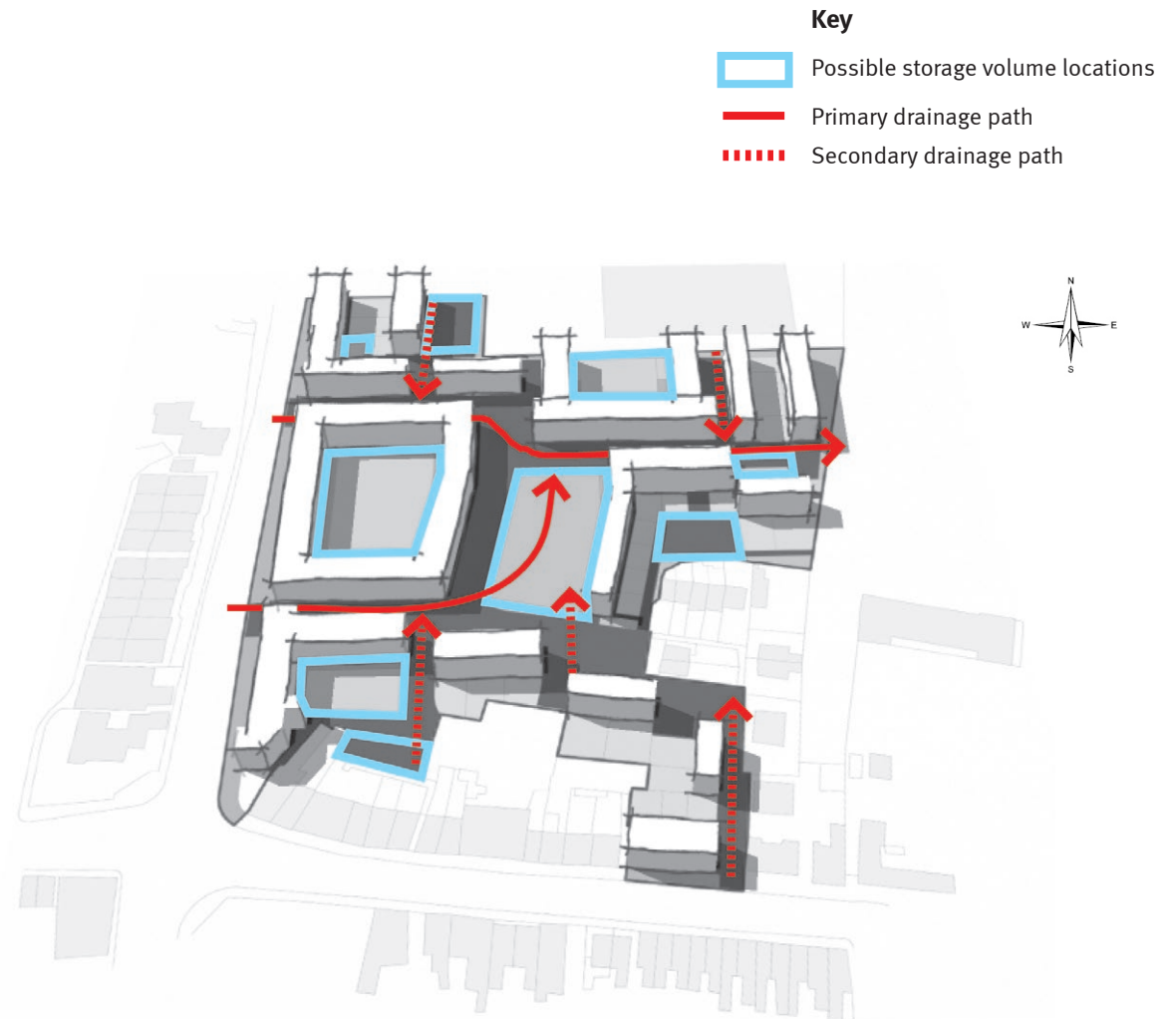

Figure 4.2.4.2: Initial assessment of flow routes and potential storage volumes

Case Study:**Scheme:** Upton**Location:** Northampton, Northamptonshire**Techniques:** Swales

A SuDS system is integrated within this major urban extension of 1382 homes. Dealing effectively with water was a key priority following the 1998 floods and SuDS provide the major structuring element.

Source control measures restrict discharge into the surface water drainage system. The pipe and swale system in the streets stores and conveys water downstream to larger retention ponds in the playing fields.

The 1 in 30 gradient presented a challenge in terms of creating and utilising storage volumes. Where possible, swales were arranged parallel to contour lines to maximise storage and potential for infiltration.

As none of the stakeholders would agree to adopt the surface water components, Upton Management Company, which has the backing of English Partnerships and Northampton Borough Council, undertakes necessary maintenance.



Site layout and design at Upton

1. Formal water feature near the school also provides storage volume in the event of intense rainfall events
2. Weirs at intervals in the swales increase the storage volume of the swales and mitigate for the effect of the gradient on site. Swales and ponds provide green fingers extending from the country park into the public realm, enhancing amenity and biodiversity
3. Swale passes through and is integrated with amenity space adding visual and recreational interest
4. Storage swales and ponds at the end of the system allow for water to be treated, retained and discharged to the drainage system in a controlled fashion

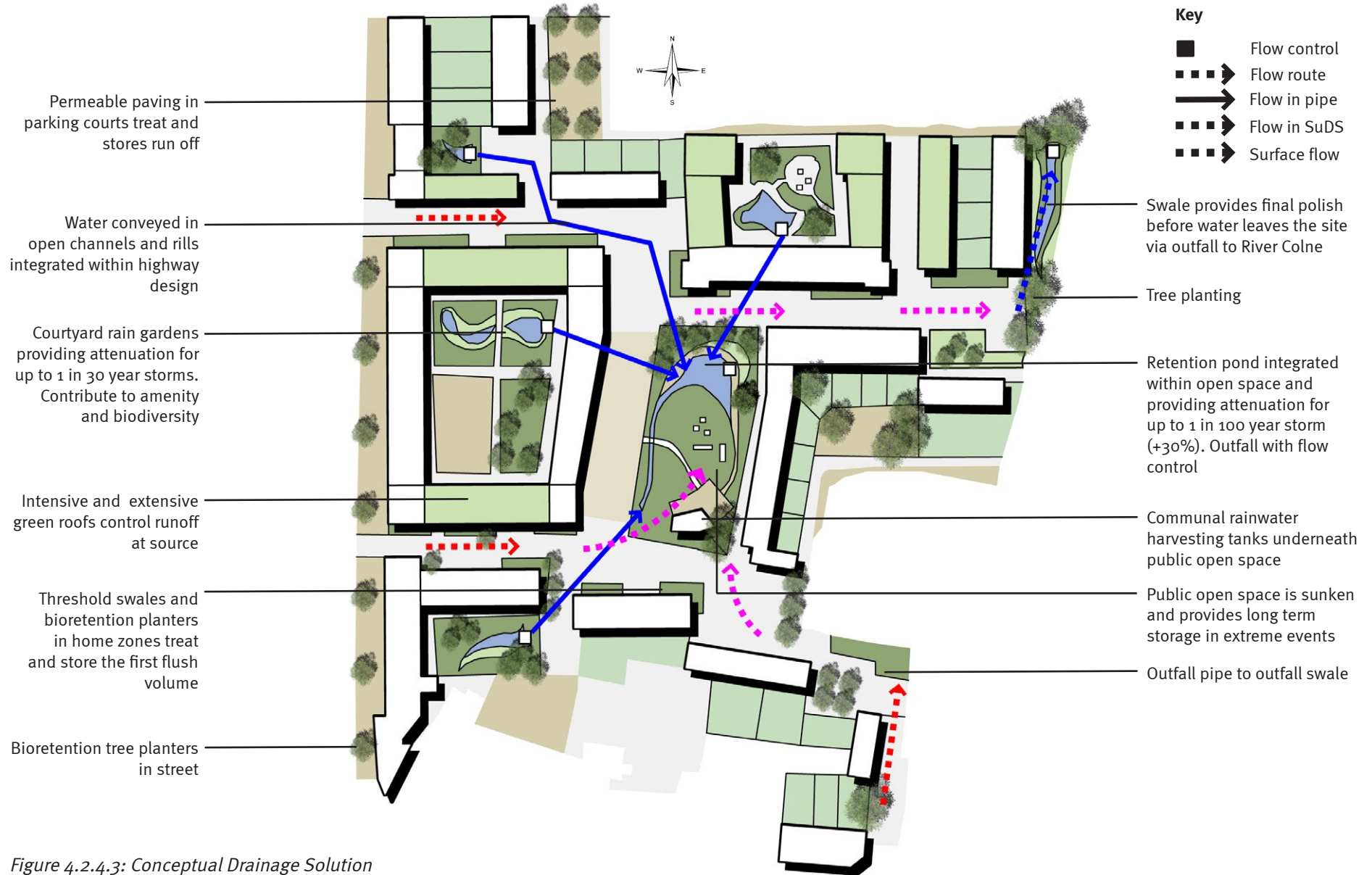

Figure 4.2.4.3: Conceptual Drainage Solution

4.3 Schools

The following pages illustrate a number of case studies of SuDS, which have been designed into school grounds.

Case Study:

Scheme: Sidwell Friends Middle School

Location: Washington DC, USA

Techniques: Rain gardens

The masterplan and site design at Sidwell Friends School includes a central courtyard with a constructed wetland designed to utilize storm and wastewater for both ecological and educational purposes.

The plan integrated water management solutions into the landscape, inextricably linking the building to its site. The wetland becomes a “working landscape”; using biological processes to clean water while providing students with a vivid example of how such systems work in nature (Andropogon Associates, 2011).



Sidwell Friends Middle School (Andropogon Associates, 2011)

1. Surface water run off passes through a series of terraced rain gardens
2. Access and seating provided within the SuDS feature
3. A variety of vegetation types are planted within the terraced areas
4. Clean, treated water flows to a pond at the end of the system

Case Study:**Scheme:** Sharrow School**Location:** Sheffield, South Yorkshire**Techniques:** Green Roof

Sheffield's newest Local Nature Reserve is the first in the country to be located on top of a building. It has been designated due to its ecological importance and value to the local community.

The 2000 square metre roof was designed to represent the variety of habitats found in Sheffield – Peak District limestone grassland, wildflower meadows, urban brownfield and a wetland area with a small pond. Bird tables and insect feeders attract wildlife and a weather station and webcam have been installed to provide research opportunities.

The substrate consists of over 200 tonnes of crushed brick, organic greenwaste and limestone. Some areas were planted with shrubs and flowers while other areas were left to see what grew naturally.

Green roofs are a useful technique for providing above ground attenuation in the flood plain.



Green roof at Sharrow School

1. Access to the roof provided by designated and protected walkway
2. A range of habitats have been created by varying the type and depth of substrate across the roof
3. Habitats created include limestone grassland, urban brownfield and a small wetland area
4. Anchorage points at edge to allow safe maintenance

Case Study:**Scheme:** Mt Tabor School**Location:** Portland, Oregon, USA**Techniques:** Rain garden

In 2007, the Portland Bureau of Environmental Services implemented a stormwater retrofit at this middle school. It transformed an asphalt parking area into a rain garden, installed a vegetated swale within the main car park and planters along the building. A curb extension planter was also built out next to the school entrance along the streets.

The rain garden collects, stores and treats run off from the school roof and playgrounds. Water from the roof is conveyed directly to the rain garden through concrete guttering and water from the playground enters through a large trench drain.

The system is designed to have a ponding depth of 15-20cm with an infiltration rate of 4-6cm per hour, depending on the size of the rainfall event. Overflow is directed to the combined system.

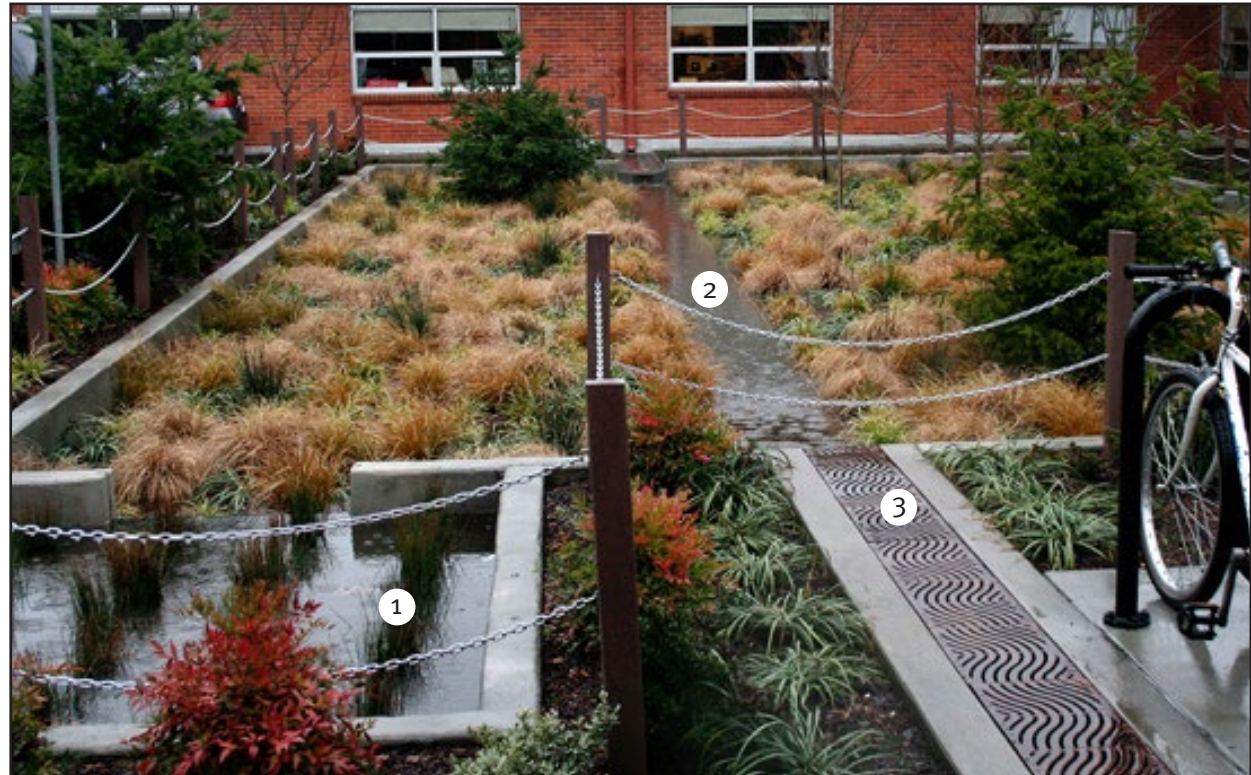

Rain garden inundated during heavy downpour

1. Forebay treats run off from the playground before it drains into the rain garden
2. Gravel filter drain
3. Concrete rill conveys water from the roof

4.4 Roads

Case Study:

Scheme: Oxfordshire County Council

Location: Oxfordshire (Various)

Techniques: Swales, detention basins, permeable paving, soakaways

Oxfordshire County Council have been pioneering the design and adoption of SuDS in highways. SuDS is now an integral part of the planning process.

Developments in Oxfordshire have featured a range of alternatives to conventional drainage including swales, wetlands and balancing ponds.

In smaller developments, Oxfordshire County Council are insisting that all roads are built using porous surfacing, which they say is still performing well after ten years.



Swale



Permeable paving



Detention basin

>>Retention pond, Beaulieu Park, Essex



5.0 APPENDICES

IN THIS SECTION

- Appendix 1: Rainwater Harvesting and Greywater Recycling 69
 - 5.1 Introduction 69
 - 5.2 Rainwater Harvesting..... 69
 - 5.3 Greywater Recycling..... 72
 - 5.4 Design Examples..... 75
 - 5.4.1 Residential Rainwater Harvesting..... 75
 - 5.4.2 Rainwater Harvesting in larger buildings..... 76
 - 5.4.3 Residential Greywater Recycling 77
 - 5.4.4 Greywater Recycling in larger buildings..... 78

Appendix 1: Rainwater Harvesting and Greywater Recycling

5.1 Introduction

On average, every person in England and Wales uses around 150 litres* of mains water per day (l/p/day), though there is potential for this to be reduced through water reuse systems.

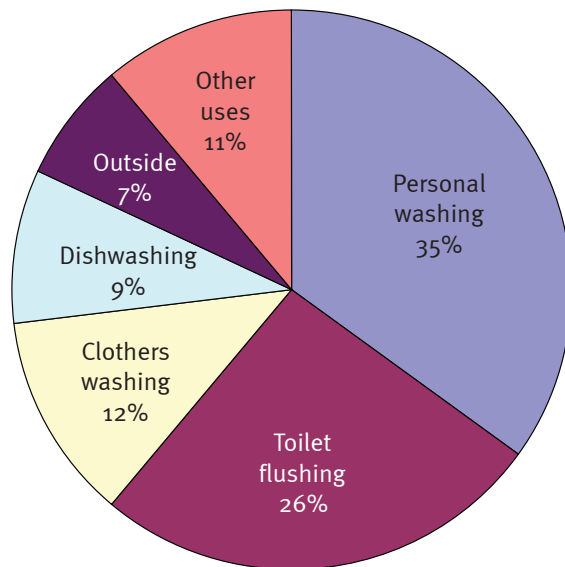

*Measured total England and Wales microcomponent use 2009-10 (%) (Source: based on Ofwat data)

The most common systems used in the UK are rainwater harvesting and greywater recycling. The main reasons for installing water reuse systems are potential environmental benefits, possible financial savings and to meet regulations and standards. This section explains what the different systems are, and highlights issues and opportunities.

5.2 Rainwater Harvesting

Rainwater harvesting is the process of collecting and using rainwater that would otherwise have gone into the drainage system or been lost through evaporation. Once collected and stored it can be used for non-potable purposes, including toilet flushing, garden watering and, for higher quality harvested water, clothes washing using a washing machine.

Rainwater harvesting should be seen as both stand alone and an integral part of a wider strategy that includes SuDS, flood alleviation and water conservation, in response to changing climate and increased usage.

Possible benefits of rainwater harvesting

- It is estimated that domestic systems could reduce the mains water consumption by up to 50% rising to more than 80% in commercial applications. (UKRHA figures).
- Rainwater is a free resource that is naturally

recycled through the water cycle.

- Part of a wider sustainable approach to the management of water in the environment.
- Reduced utility bills and the reduction of running costs.
- Achievement of sustainability standards and help in achieving planning permission.
- Storing of source water for alternative use or as part of a SuDS system.

Evolving issues relating to rainwater recycling:

- Systems can be expensive to buy, though payback periods are improving as the market matures and water utility prices increase.
- Increasing water metering - in 2011 only 37 per cent of homes were metered.
- Regulations and standards are emerging to reassure consumers.
- Population growth and lifestyle changes mean water supply is struggling to keep up with demand.
- Annual rainfall predicted to fall in the Eastern regions.

System Types and Design Considerations

To be economic and practical, the system design should consider roof area, roof connections, water demand, storage size required, location of facilities including whether storage will be above or below ground, potential pre-treatment, design of collecting surfaces,

appearance of facilities and any potential for combining facilities. Different rainwater harvesting measures should be considered according to the nature of the development and site. For example, it will nearly always be more economical to install harvesting below ground on new development whereas it will be more cost effective to install features above ground in existing development.

Rainwater harvesting is traditionally collected from roofs but can also be collected from ground surfaces. Rainwater from roofs does not require treatment if it is used for non-potable purposes, such as watering a garden, but pumping might be required if it is collected at a level below its intended end use. Rainwater collected from ground surfaces may be more polluted and require treatment before reuse, especially if it is stored in an above ground basin. Effective rainwater treatment should consider the materials coming into contact with the runoff, for example checking for chemicals and other pollutants.

Rainwater storage should be sized considering rainfall patterns and expected water demands using the BS 8515:2009 “intermediate approach”. Optimising storage size for demand requirements can reduce land take needs. It is also important to take advantage of economies of scale. If underground storage

can be used, land take can be reduced. Above-ground storage is preferable where geological conditions consist of shallow rock or a high water table. For communal rainwater harvesting, storage could take the form of either an above ground or below ground communal tank, or an above ground basin. With regard to design and layout, above ground water storage should consider visual impact and storage facilities must be accessible for easy maintenance.

Types of rainwater harvesting systems range in terms of complexity and size ranging from complex district-wide systems to simple household systems linked to a water butt. However, most share the same principles.

Once collected in storage tanks and treated the harvested water can be reused using three types of distribution system:

- Pumped directly to points of use
- Fed by gravity to points of use
- Pumped to an elevated cistern and fed by gravity to the points of interest

Rainwater harvesting systems can be combined with grey water recycling systems to form an integrated process. However, given the issues and costs of mixing water, these should only generally be considered when either source would not provide sufficient water on its own.

Rainwater harvesting systems are relatively easy to manage. For water collected from roofs, there will be a need to clean gutters. Each stage of treatment will require maintenance – pre-treatment system performance, water quality

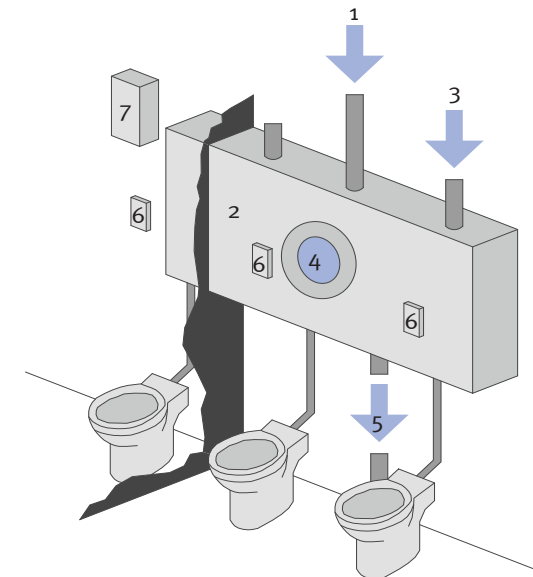

in storage, and disinfection (second stage of treatment if required) infrastructure.

A typical passive rainwater collection system directly conveys rainwater into flushing tanks. (Pipex Flowstow system)

- 1-Rainwater outlet with filter, 2-Flushing tank
- 3-Mains water inlet, 4-Inspection cover
- 5-Overflow, 6-Full and half flush button, 7-Control system

Appropriate maintenance access will need to be considered at all treatment stages. Metering and monitoring will also be required for communal systems.

A typical collection, treatment and storage system is shown and described as follows:

1. Rainwater is collected from the roof area or hard standing,
2. Filter system prevents solids from entering the holding tank,
3. Water enters tank through smoothing inlet which stops settled sediment from being disturbed,
4. A suction filter prevents the uptake of floating matter when water is drawn up,
5. A pump pressurises the water,
6. A control unit monitors water levels - if these drop too low mains water will top the system up,
7. An air gap installed in order to prevent back flow of rainwater into the mains,
8. An overflow trap allows floating material to be skimmed off into the storm drain,
9. Rainwater soaking through a permeable pavement can also be collected,
10. Oil trap fitted to prevent contamination entering the system from ground surfaces, though additional filtration and disinfectant might also be needed.

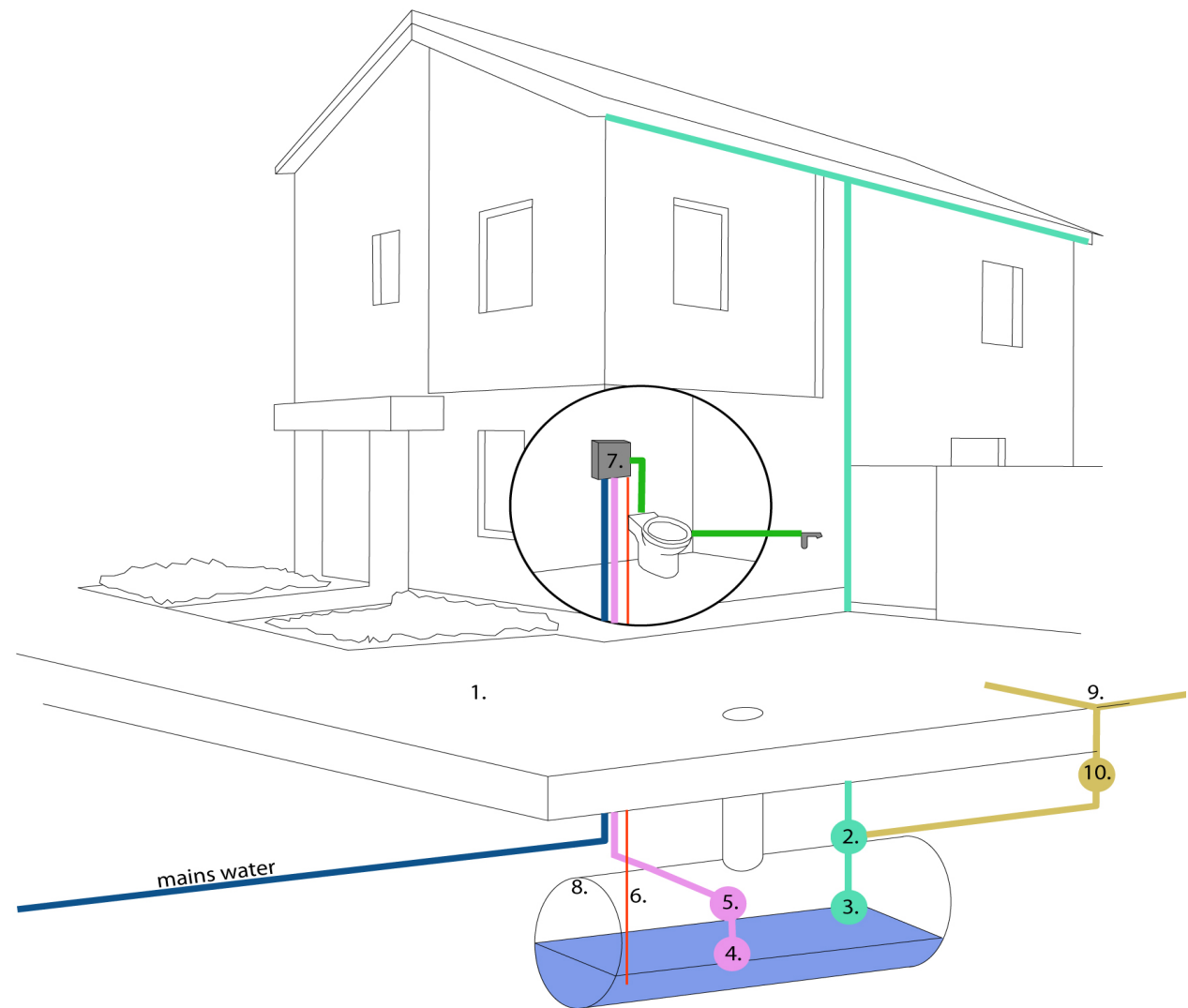

5.3 Greywater Recycling

Introduction

Greywater is wastewater which can be collected from showers, baths, washbasins, washing machines and kitchen sinks, though this guidance focuses on the first three less contaminated sources. It gets its name from its cloudy appearance and from its status as being between fresh, potable water (known as “white water”) and sewage water (“black water”). After treatment greywater can be recycled for use around the home for purposes which do not require drinking water quality.

Domestic systems, which this guidance focuses on, typically collect and store greywater before reusing it to flush the toilet. More advanced systems treat greywater to a standard that can be used in washing machines for example. The most basic systems simply divert cooled and untreated bath water to irrigate the garden. Greywater recycling can be installed in new or existing dwellings.

Possible benefits of greywater recycling:

- Reduced mains water usage, e.g. greywater toilet flushing should reduce home usage by over a quarter.
- Sourcing reliability compared to rainwater

harvesting.

- Reduced demand for water helps protect wetland habitats.
- Reduced water discharge into the sewerage system.
- Compliance with regulations and standards relating to water consumption.

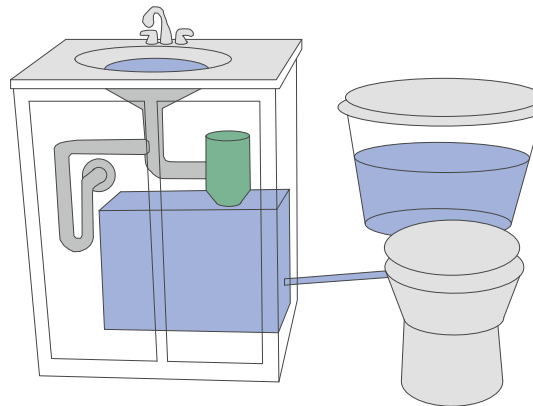

A typical short retention bathroom grey water recycling system for toilet flushing

Evolving issues relating to greywater recycling:

- Systems can be expensive to buy, maintain and run, though payback periods are improving as the market matures and water utility prices increase.
- Reliability has significantly improved with

the advancement of technologies.

- Increasing water metering - in 2011 only 37 per cent of homes were metered.
- Increased embodied and operational energy use compared to mains water.
- Mixed public perceptions – influenced by management systems, contamination levels, usage, potential contact and marketing.
- Regulations and standards are emerging to reassure consumers.

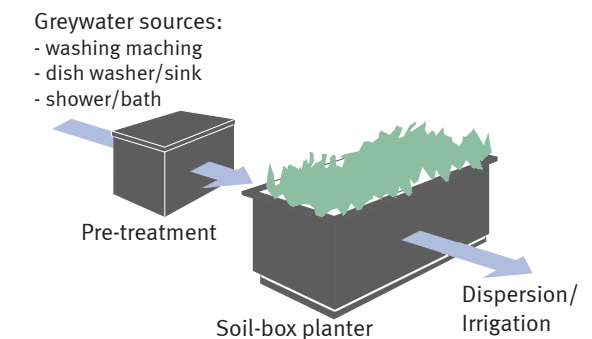

A typical biological soil box filter system

System Types and Design Considerations

There are various greywater systems which might be considered, varying significantly in complexity and size. However, most have in common features such as a tank if storing

water, a pump, a distribution system and, where it is needed, some sort of treatment.

Greywater stored for any length of time has to be treated as otherwise it deteriorates rapidly. This is because it is often warm and rich in organic matter, providing an ideal breeding ground for bacteria. A key consideration when choosing a greywater recycling system type should be the predicted water demand and supply for the user group over time.

The main types of greywater recycling systems are discussed as follows according to the type of treatment used:

Direct Reuse Systems (no treatment) - There is potential to very cheaply reuse untreated greywater if the water is not stored for long. Most commonly this involves less contaminated water simply being redirected for use in the garden, for example using a pump and hose for cooled bath or shower water.

Short Retention Systems – These take greywater from the bath or shower and apply a very basic treatment such as skimming debris off the surface and allowing particles to settle to the bottom of the tank. Potential reuse includes for toilet flushing. Unused water can be released after a certain time and the system

is topped up with mains water. These systems are relatively cheap to buy and run, and can be located in the same room as the source of greywater.

Basic Physical and Chemical Systems – A number of systems filter to remove debris from greywater and use chemical disinfectants to prevent bacterial growth in storage. Water saving benefits should be considered against the environmental impact of disinfectants, maintenance requirements and possible odour issues.

Biological Systems – These vary in complexity, with systems available for groups of dwellings as well as individual homes. Active bacteria are used to remove organic material from wastewater using air-induced filtration and digestion principles. Biological systems generally use reed beds, with UV filters to kill remaining bacteria. Biological systems normally require a relatively large outside area, such as a roof or garden.

Bio-mechanical - The most advanced domestic systems combine biological and physical treatment to produce the highest quality water, but use significant amounts of energy and are more expensive to buy and install.

Integrated Greywater Recycling / Rainwater Harvesting Systems – Given the issues and

costs of mixing water, these should only generally be considered when either source would not provide sufficient water on its own.

Regulations and Standards

- BS 8525-2:2011 Greywater Systems. Domestic Greywater Treatment Equipment. Requirements and Test Methods - embeds water quality parameters relating to greywater reuse applications.
- The Building Regulations (Part G) - requires the potential wholesome water consumption of new dwellings to not exceed 125 l/p/day.
- Code for Sustainable Homes - requires reduced mains water consumption, down to less than 80 l/p/day to meet the highest levels.
- The Water Supply (Water Fittings) Regulations 1999 – covers back flow prevention to avoid cross-contamination of mains water.
- Guidance on Marking and Identification of Pipe work for Reclaimed (Greywater) Systems (WRAS, 1999).

Further Guidance and References

- Environment Agency (2011) Greywater for Domestic Users: An informative guide
- PUSH (2009) Draft PUSH Sustainable Development SPD Resource Document
- Anglian Water & CIPHE, Water Reuse Systems
- CIRIA (2001) Rainwater and Greywater Reuse in Buildings
- BSI (2010) BS 8525-1:2010 Greywater Systems. Code of practice
- Environment Agency, Conserving Water in Buildings
- WRAS (1999) Reclaimed Water Systems
- CIRIA (2010) Guidance on Water Cycle Management for New Developments (C690)
- UK Rainwater Harvesting Association at <http://www.ukrha.org/>
- Pipework for Reclaimed (Greywater) Systems (WRAS, 1999).

5.4.1 Rainwater Harvesting case study

Development: Green Space project
Type: Rainwater Recycling (residential)
Location: Mendip Place, Chelmsford
Techniques: Rainwater Harvesting

In 2010 Chelmer Housing Partnership completed 10 eco-houses on a former garage site in Chelmsford. A key objective of the scheme was to achieve Code for Sustainable Homes Level Six using innovative technologies.

Rain rainwater harvesting reduces water consumption, using relatively simple and inexpensive systems which utilises rainwater from roofs, redirecting it to individual water butts located in gardens. The primary purposes are to reduce water usage in the garden and costs in use. This forms part of a wider water management strategy for the scheme including reduced flow taps/showers in each property.

The scheme includes a range of other sustainability features, such as electricity generating PV panels, a bio-mass heating and hot water system, high levels of thermal insulation and composting areas. Energy and water use are being monitored with results informing the association's long term development strategy.



Chelmer Housing Partnership

5.4.2 Rainwater Harvesting case study

Development: Columbus School and College, Essex Building Schools for the Future

Type: Rainwater Recycling (school)

Location: Chelmsford

Techniques: Rainwater Harvesting

Rainwater is harvested from the school and college to form a combined system with central storage and treatment. The water is then distributed for reuse in toilets.

Rainwater harvesting forms part of a wider water management strategy which includes water efficient fittings and fixtures, and a leak detection system. Drought resistant planting is also being used for landscaping to minimise the need for watering. The scheme also incorporates SuDS to attenuate water run off and mitigating against the risk of localised flooding.

The scheme forms part of a wider strategy by Essex County Council to improve sustainability standards and reduce costs. Other schools featuring rainwater harvesting include Hutton Willowbrook Primary School in Brentwood and Epping Primary School. Monitoring of different systems is helping inform future schemes.



5.4.3 Greywater Recycling case study

Scheme: Affordable housing (Moat)

Location: Heybridge, Essex

Techniques: Greywater recycling (Basic physical and chemical system)

In 1997 when the technology was in its infancy, a housing association, in partnership with Essex and Suffolk Water and the BRE developed three homes in Heybridge incorporating individual greywater systems. The Water Dynamics Well Butt System takes water from the bath and hand basin, and filters and disinfects it before the water is reused to flush toilets.

Related findings:

- Unexpected failure of the system components reduced the water saved
- Lifestyle patterns significantly influenced water savings
- Testing of the greywater raised no health concerns, though water turbidity increased over time without regular upkeep.



Monitoring of the system produced varying results:

Household Consumption:

Property	Occupancy	Time system worked	Potable water saved
3 bed house	3	63%	53%
3 bed house	3	83%	65%
4 bed house	7	39%	24%

5.4.4 Greywater Recycling case study

Scheme: Premier Inn hotels

Location: Doncaster and others

Techniques: Greywater recycling

In 2008 Premier Inn had an Aquacontrol greywater recycling system installed in their Doncaster Hotel. This was integral to owners Whitbread's ongoing strategy to tackle water consumption issues working closely with Waterscan their water management partners. The hotel is currently recycling 2,800 litres of water per day with a reduction in mains water consumption of 19%. In 2008 a combined rainwater and greywater recycling unit was also installed in Premier Inn's new green flagship Tamworth Hotel, with greywater recycling providing 100% of the hotel's toilet water use.



The Premier Inn greywater system collects greywater from baths and showers. In the collection tank aeration encourages natural biological cleansing of bio-degradable particles, before further filtration removes remaining particles. Filtered water then enters a clear water tank before being pumped to a water management system which supplies green water for flushing toilets, laundry, cleaning and irrigation. A Waterscan greywater system now goes into all new build Premier Inn's as standard with an option for a combined system incorporating rainwater harvesting. Waterscan also maintain the systems.

»Retention pond takes run off from roof at M42 Services, Hopwood (Robert Bray Associates)



6.0 GLOSSARY OF TERMS AND ACRONYMS

6.0 GLOSSARY OF TERMS AND ACRONYMS

Amenity	The quality of being pleasant or attractive; agreeableness.	Conventional drainage	The traditional method of drainage surface water using subsurface pipes and storage tanks.
Attenuation	Reduction of peak flow and increased duration of a flow event.	Conveyance	Movement of water from one location to another.
BAP	Biodiversity Action Plan	Defra	Department for Environment, Food and Rural Affairs.
Basin	A ground depression acting as a flow control or water treatment structure that is normally dry and has a proper outfall, but is designed to detain stormwater temporarily.	Design criteria	A set of standards agreed by the developer, planners, and regulators that the proposed system should satisfy.
Biodegradation	Decomposition of organic matter by micro-organisms and other living things.	Detention basin	A vegetated depression that is normally dry except following storm events. Constructed to store water temporarily to attenuate flows. May allow infiltration of water to the ground.
Biodiversity	The diversity of plant and animal life in a particular habitat.	ECC	Essex County Council.
Bioretention area	A depressed landscaping area that is allowed to collect runoff so it percolates through the soil below the area into an underdrain, thereby promoting pollutant removal.	Exceedance flow route	Design and consideration of above-ground areas that act as pathways permitting water to run safely over land to minimise the adverse effect of flooding. This is required when the design capacity of the drainage system has been exceeded.
BRE	Building Research Establishment.	Filter drain	A linear drain consisting of a trench filled with a permeable material, often with a perforated pipe in the base of the trench to assist drainage.
Catchment	The area contributing surface water flow to a point on a drainage or river system. Can be divided into sub-catchments.	Filter strip	A vegetated area of gently sloping ground designed to drain water evenly off impermeable areas and to filter out silt and other particulates.
CDM	Construction Design and Management Regulations 2007.	Filtration	The act of removing sediment or other particles from a fluid by passing it through a filter.
CIRIA	Construction Industry Research and Information Association.	Flow control device	A device used for the control of surface water from an attenuation facility, e.g. a weir.

Geocellular structure	A plastic box structure used in the ground, often to attenuate runoff.	Interception storage	The capture and infiltration of small rainfall events up to about 5mm.
Geotextile	A plastic fabric that is permeable.	Long term storage	The volume required to be stored in addition to the attenuation storage volume to reduce the rate of discharge of flows above the greenfield runoff volume.
Green roof	A roof with plants growing on its surface, which contributes to local biodiversity. The vegetated surface provides a degree of retention, attenuation and treatment of rainwater, and promotes evapotranspiration.	Management train	The management of runoff in stages as it drains from a site.
Greenfield runoff	The surface water runoff regime from a site before development.	Non-performance bond	A written financial guarantee (usually a bank or insurance company) given by a developer underwriting their agreement to construct the works to an agreed standard.
Groundwater	Water that is below the surface of ground in the saturation zone.	Pavement	Technical name for the road or car park surface and underlying structure. N.B. the path next to the road for pedestrians is properly termed the footway.
Habitat	The area or environment where an organism or ecological community normally lives or occurs.	Permeability	A measure of the ease with which a fluid can flow through a porous medium. It depends on the physical properties of the medium, for example grain size, porosity and pore shape.
Highway Authority	A local authority with responsibility for the maintenance and drainage of highways maintainable at public expense e.g. Essex County Council.	Permeable pavement	A permeable surface that is paved and drains through voids between solid parts of the pavement.
Impermeable	Will not allow water to pass through it.	Piped system	Conduits generally located below ground to conduct water to a suitable location for treatment and/or disposal.
Impermeable surface	An artificial non-porous surface that generates surface water runoff after rainfall.		
Infiltration	The passage of surface water into the ground.		
Infiltration basin	A dry basin designed to promote infiltration of surface water into the ground.		
Infiltration trench	A trench, usually filled with stone, designed to promote infiltration of surface water to the ground.		

Pollution	A change in the physical, chemical, radiological or biological quality of a resource (air, water or land) caused by man or man's activities that is injurious to existing, intended or potential uses of the resource.	Rill	An open surface water channel with hard edges, used to collect and convey runoff. They can be planted to provide a cleaning function.
Pond	Permanently wet basin designed to retain stormwater and permit settlement of suspended solids and biological removal of pollutants.	Risk risk management authority	As defined in the Flood and Water Management Act are the Environment Agency, a lead local flood authority, a district council for an area for which there is no unitary authority, an internal drainage board, a water company and a highway authority
Prevention	Site design and management to stop or reduce the occurrence of pollution and to reduce the volume of runoff.	Runoff	Water flow over the ground surface to the drainage system. This occurs if the ground is impermeable, saturated or rainfall is particularly intense.
POS	Public Open Space.	Sediments	Sediments are the layers of particles that cover the bottom of waterbodies such as lakes, ponds, rivers and reservoirs.
Rain Garden	A planted basin designed to collect and clean runoff.	Sewer	A pipe or channel taking domestic foul and/or surface water from buildings and associated paths and hard-standings from two or more cartilages and having a proper outfall.
Rainfall event	A single occurrence of rainfall before and after which there is a dry period sufficient to allow its effect on the drainage system to be defined.	Sewerage undertaker	Collective term relating to the statutory undertaking of water companies that are responsible for sewerage and sewage disposal including surface water from roofs and gardens of premises.
Recharge	The addition of water to the groundwater system by natural or artificial processes.	Silt	The generic term for waterborne particles with a grain size of 4-63mm, ie. between clay and sand.
Retention pond	A pond where runoff is detained for a sufficient time to allow settlement and biological treatment of some pollutants.	Site/regional control	Manage runoff drained from a sub-catchment or several sub-catchments. The controls deal with runoff at a catchment scale rather than at source.
Return period	Refers to how often an event occurs. A 100-year storm refers to the storm that occurs on average once every hundred years. In other words, its annual probability of exceedance is 1% (1/100).		

Soakaway	A sub-surface structure into which surface water is conveyed, designed to promote infiltration.	Wetland	Flooded area in which the water is shallow enough to enable the growth of bottom-rooted plants.
Source control	The control of runoff at or near its source.	1 in X year event	This is the recurrence interval and is based on the probability that a given event will recur e.g. a '1 in 100 year event' would be expected to occur once every 100 years and has a 1% chance of occurring in a given year.
Sub-base	A layer of material on the sub-grade that provides a foundation for a pavement surface.		
SuDS	Sustainable Drainage Systems. A sequence of management practices and control structures designed to drain surface water in a more sustainable fashion than some conventional techniques.		
SuDS Team (ECC)	The SuDS Team sits within the Flood & Water Management Team at Essex County Council		
Surface water	Water that appears on the land surface ie. lakes, rivers, streams, standing water, and ponds.		
Swale	A shallow vegetated channel designed to conduct and retain water, but may also permit infiltration. The vegetation filters particulate matter.		
Treatment	Improving the quality of water by physical, chemical or biological means.		
Watercourse	A term including all rivers, streams, ditches, drains, cuts, culverts, dykes, sluices, and passages through which water flows.		
Water butt	Small scale garden water storage device which collects rainwater from the roof via the drainpipe.		
Water quality treatment volume	The proportion of total runoff from impermeable areas that is captured and treated to remove pollutants.		

7.0 REFERENCES

- Andropogon Associates (2011) Photograph accessed online at <http://andropogon.com/sidwell-friends-school-middle-school-addition>
- BACA Architects & BRE (2009) The LiFE Project Report. Bracknell.
- CIRIA (2006) Designing for exceedence in urban drainage- good practice (C635). London.
- CIRIA (2007) The SuDS Manual (C697)
- CIRIA (2010) Planning for SuDS- making it happen (C687)
- HSE (2007) Construction, Design and Management Regulations
- Future Water: The Government's water strategy for England (2008)
- Ian Yarham (2010) Photograph accessed online at www.geograph.org.uk/photo/2033292
- Sheffield City Council (2010) Photograph accessed online at www.sheffield.gov.uk/out--about/parks-woodlands--countryside/ecology-service/local-nature-reserves/sharrow-school-green-roof.html

8.o FIGURE TABLE

Figure 1.2.1	SuDS objectives (CIRIA, 2007)	p3	Figure 4.2.2.3	Conceptual Drainage Solution	p51
Figure 1.6.1	The SuDS management train (CIRIA, 2007)	p5	Figure 4.2.2.4	Typical section through street	p52
Figure 2.3.1	Simplified bedrock section	p8	Figure 4.2.3.1	Analysis of proposed development	p54
Figure 2.3.2	Topography of Essex	p9	Figure 4.2.3.2	Initial assessment of flow routes and potential storage volumes	p55
Figure 2.3.3	Surface geology of Essex	p10	Figure 4.2.3.3	Conceptual Drainage Solution	p57
Figure 3.1.1	Opportunities for enhancing SuDS features for wildlife (Cambourne, Cambridgeshire)	p23	Figure 4.2.3.4	Illustrative detail of street	p58
Figure 3.1.2	Services corridor	p26	Figure 4.2.4.1	Analysis of proposed development	p60
Figure 3.1.3	Delineated utility road crossing (plan)	p26	Figure 4.2.4.2	Initial assessment of flow routes and potential storage volumes	p61
Figure 3.1.4	Delineated utility road crossing (section)	p26	Figure 4.2.4.3	Conceptual Drainage Solution	p63
Figure 4.1.1	Large stand-alone balancing ponds are not the only solution	p37			
Figure 4.1.2	An integrated approach to surface water management	p37			
Figure 4.1.3	SuDS Planning Process (CIRIA, 2010)	p38			
Figure 4.1.4	SuDS Planning Process (CIRIA, 2010)	p38			
Figure 4.1.5	SuDS Planning Process (CIRIA, 2010)	p39			
Figure 4.1.6	SuDS Planning Process (CIRIA, 2010)	p39			
Figure 4.1.7	SuDS Planning Process (CIRIA, 2010)	p39			
Figure 4.2.1	SuDS Selection Flowchart (adapted from CIRIA, 2007)	p40			
Figure 4.2.1.1:	Analysis of proposed development	p42			
Figure 4.2.1.2	Initial assessment of flow routes and potential storage volumes	p43			
Figure 4.2.1.3	Conceptual Drainage Solution	p45			
Figure 4.2.1.4	Typical section through mews courtyard	p46			
Figure 4.2.2.1	Analysis of proposed development	p48			
Figure 4.2.2.2	Initial assessment of flow routes and potential storage volumes	p49			

This information is issued by
Essex County Council Environment, Sustainability & Highways
You can contact us in the following ways:

By email:
suds@essex.gov.uk

Visit our website:
www.essex.gov.uk/flooding

By telephone:
01245 437062/437138

By post:
**Essex County Council, Environment, Sustainability & Highways,
E3 County Hall, Market Road, Chelmsford, Essex CM1 1QH**

Read our online magazine at **www.essex.gov.uk/ew**

Follow us on  **Essex_CC**

Find us on  **facebook.com/essexcountycouncil**

The information contained in this document can be translated, and/
or made available in alternative formats, on request

